

M18CBS125-0 BTY. BAND SAW XXX

4933447150 - M18CBS125-0 - 4000447151

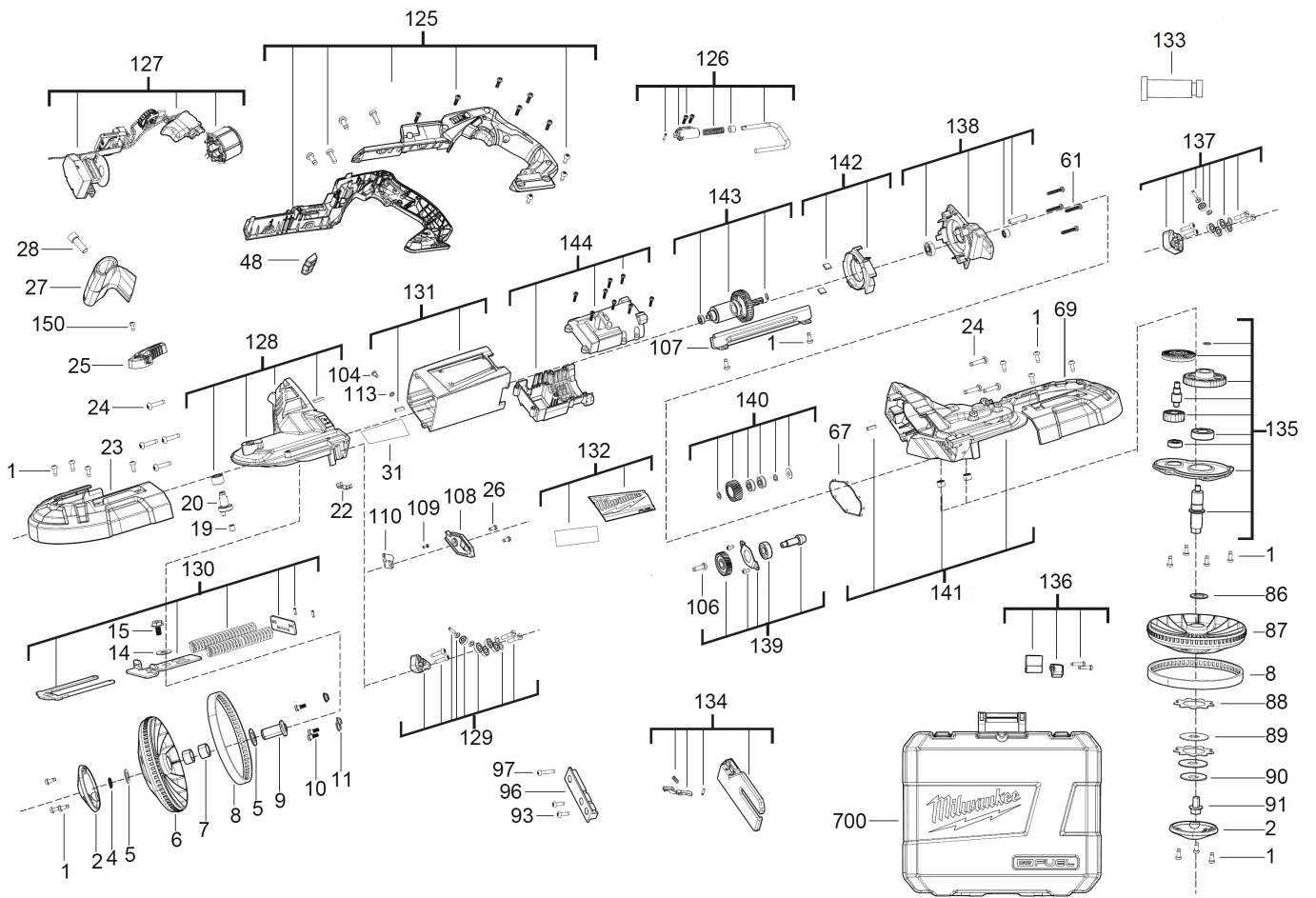

Position	Quantity	Description	Part number	EAN
0001	23	SCREW TORX SCREW	06825314	4002395851935
0002	2	PULLEY	4931436230	4002395885480
0004	1	PROTECTION WASHER	4931436231	4002395885497
0005	2	SPACER	4931436232	4002395252008
0006	1	PULLEY	4931436233	4002395252015
0007	2	BUSH	4931436234	4002395252022
0008	2	BELT	4931436235	4002395252039
0009	1	BOLT	4931436236	4002395252046
0010	3	SCREW	4931436237	4002395252053
0011	3	BUSH	4931436238	4002395252060
0014	1	WASHER	4931436239	4002395252077
0015	1	SCREW	660988001	4002395903795
0019	1	BUSH	4931436240	4002395252084
0020	1	SHAFT	4931436241	4002395252091
0022	1	STAMP	4931436242	4002395252701
0023	1	PULLEY	4931436243	4002395252718
0024	7	SCREW	4931436244	4002395252725
0025	1	LEVER	4931436245	4002395252732
0026	3	SCREW	660023001	4002395830060
0027	1	HANDLE	4931436246	4002395252749
0028	1	SCREW	4931436247	4002395252756
0031	1	RATING PLATE	4931436248	4002395252763
0048	1	PUSH-BUTTON	4931436249	4002395253456
0061	4	SCREW	4931436250	4002395253449
0067	1	SEAL	4931436251	4002395253463
0069	1	SAW PROTECTION	4931436252	4002395253470
0086	1	STAMP	4931436253	4002395253487
0087	1	PULLEY	4931436254	4002395253494
0088	2	COUPLING	4931436255	4002395254125
0089	2	COUPLING	4931436256	4002395254132
0090	1	SPRING WASHER	4931436257	4002395254149
0091	1	SCREW	4931436258	4002395252770
0093	2	SCREW	4931436259	4002395252787
0096	1	COVER PLATE	4931436260	4002395254156
0097	1	SCREW	4931436261	4002395252794
0104	3	SCREW	4931435162	4002395860760
0106	1	SCREW	4931436262	4002395253401
0107	1	GUARD	4931436263	4002395254163
0108	1	COVER	4931436264	4002395254170
0109	1	SCREW	4931436265	4002395253418
0110	1	Display	4931436266	4002395254187
0113	1	PROTECTION WASHER	680866003	4002395823895
0125	1	HANDLE COVER	4931436267	4002395253425
0126	1	HOOK	4931436268	4002395254101
0127	1	ELECTRIC ELEMENT	4931436269	4002395254194
0128	1	PULLEY	4931436270	4002395254118
0129	1	SUPPORT ROLL HOLDER	4931436271	4002395254804
0130	1	TENSION SPRING	4931436272	4002395254811
0131	1	MOTOR HOUSING	4931436273	4002395253432
0132	1	NAME PLATE	4931436274	4002395254828

Position	Quantité	Désignation	Référence	EAN
0133	1	GREASE	49085271	4002395775415
0134	1	ACCEPTANCE	4931436275	4002395254835
0135	1	GEAR BOX	4931436276	4002395254842
0136	1	BRUSH	4931436277	4002395254859
0137	1	GUIDE ROLLER	4931436278	4002395254866
0138	1	PACKING SET	4931436279	4002395254873
0139	1	BEVEL GEAR PAIR	4931436280	4002395254880
0140	1	GEAR BOX KIT	4931436281	4002395254897
0141	1	GEAR BOX COVER	4931436282	4002395252107
0142	1	FAN HOUSING	4931436283	4002395252114
0143	1	ARMATURE	4931436284	4002395252121
0144	1	MOTOR HOUSING	4931436285	4002395252138
0150	1	SCREW	4931452223	4002395180370
0700	1	CARRYING CASE	4931436229	4002395885473