



*Issue 4*

## SSDK12M – SSDK16M – SSDK20M

12 to 20kVA Multi-Phase Generators



---

### Handbook & Operation Manual

---

# Contents

## **3 Introduction**

## **3 Warranty Statement**

## **3 Amendments**

## **4 Identification**

## **5 Specification**

- 5 AC Output Protection
- 5 AC Output Earthing Method
- 6 Running Hours
- 6 Engine
- 6 AC Alternator
- 6 Dimensions & Weights

## **7-8 Control Panel Identification**

## **9 Generator Safety**

- 9 Warning Signage
- 10 Personal Safety
- 10 Auxiliary Power
- 11 Operating Environment
- 11 Temperature Range
- 11 Reference Relative Humidity
- 11 Reference Barometric Pressure
- 11 Flammable Environment
- 11 Saline Environment

## **11 Safety Considerations**

- 11 General
- 11 Fuel
- 11 Lubricating Oil
- 12 Bunded Fuel Tank
- 12 Safe Lifting
- 12 Earth Connections
- 12 Fumes
- 12 Noise
- 12 Battery Acid
- 12 Fire
- 13 Hot Parts

## **13 Operating Instructions**

- 13 Pre-starts Checks
- 13 Check Battery Isolator Key & Location
- 13 Check Oil Level - How to
- 14 Adding Engine Oil
- 15 Check Coolant Level
- 15 Check Fuel Level
- 15 Control Panel Checks
- 15 Starting the Generator - Manual Start
- 16 Applying Load
- 16 Stopping the Generator - Manual Stop
- 16 Emergency Stop
- 16 Remote Start/Stop - 2-wire
- 16 2-wire remote and ATS Auto Start/Stop Connection Location
- 17 Hard Wire Terminals - Connection & Location
- 17 Long Term Storage

## **18 DSE 3110 Control Module - Overview**

- 18 DSE 3110 Operation
- 18 Starting Sequence
- 18 Timer Icon
- 18 Engine Running
- 19 Viewing the Instruments
- 19 AUTO MODE - Start/Stop Operation
- 19 Waiting in AUTO MODE

## **19 External Fuel Source**

- 19 3-Way Valve(s)
- 20 Standard 12V Lift Pump
- 20 Up-rated 12V Lift Pump

## **21 Fault Finding**

- 21 Monitoring Systems
- 21 Before Fault Finding
- 21 Fault Finding - DSE 3110
- 24 Fault Finding - Kubota ECU
- 26 Fault Finding - General

*cont.*

## **27 Service and Maintenance**

- 27 Pre-service
- 27 Engine Service
- 27 Oil System Service
- 27 Oil System Location(s)
- 28 Oil System Service Procedure
- 28 Alternator Service

## **28 Road Tow Trailers**

- 28 Trailer Information
- 29 Safety Precautions
- 29 Wheels
- 29 Number Plate
- 29 Hitch Type
- 29 Pre-towing/Hitch Up
- 30 Hitching Method
- 30 Service Brake
- 30 Reversing

## **31 Spares**

- 31 Kubota Consumable Service Spares
- 31 Control Panel - AC Components
- 31 Control Panel - DC Components
- 31 General Spares
- 32 Engine Accessories
- 32 Exhaust System Spares

## **33 Exploded View**

- 33 Canopy Exploded View
- 34 Silencer Exploded View

## **35 Wiring Diagrams**

- 35 AC Multiphase Wiring - SW12036
- 36 DC Kubota 03 M Series StageV ECU DSE 3110 - SW16047 (SSDK16-20)
- 37 DC Kubota 05 Series StageV DSE 3110 - SW16061 (SSDK12)

## Introduction

This document has been produced for the owner/user of a Stephill generator. Inside this manual you will find important safety, operating, maintenance and fault finding information.

The information contained within this manual is based upon the current data available before print. Due to constant improvements on our products some information contained within this manual may change without warning. Therefore Stephill Generators Ltd reserve the right to alter specifications as and when situations demand without warning or obligation.

© Stephill Generators Ltd.

All rights reserved.

No part of this material may be reproduced in any form by any means without the written permission of Stephill Generators Ltd.

## Warranty Statement

All equipment supplied by Stephill Generators Ltd carries a warranty of 12 months from date of despatch. During the warranty period, should the plant fail due to faulty design, materials or workmanship by Stephill Generators Ltd or it's sub-contractors, we undertake to rectify the fault. Stephill Generators Ltd will accept no responsibility whatsoever for equipment that has failed due to;

Operation with incorrect fuel, lubricating oil or coolant.

Improper repair or use of parts not supplied or approved by Stephill Generators Ltd.

Lack of, or incorrect maintenance.

Fair wear and tear, misuse, negligence, accidental damage, improper storage and incorrect starting / warm-up / run-in or shutdown.

No warranty claim will be considered by Stephill Generators Ltd unless any defective parts are available for inspection by us, or our nominees, to determine the reason or cause of failure, and Stephill Generators Ltd is given the option of repair or replacement.

Stephill Generators Ltd are not responsible for incidental or consequential damages, downtime, or other costs due to warrantable failure, and unauthorised alterations made to any product supplied by Stephill Generators Ltd.

## Amendments

Issue	Amendment	Date	By

## Identification

Each Stephill generator will have a Serial/Data plate fitted to the set. In most cases this can be found on the control/socket panel of a SSDK-Range generator. Below is an example of the Serial/Data plate.

**STEPHILL GENERATORS**

5 Wallis Close  
Park Farm South  
Wellingborough  
Northants  
NN8 6AG  
Tel : +44 (0) 1933 677911  
Fax: +44 (0) 1933 677916

**SSDK20M**

		400V		230V		115V	
Standby	kVA	20	28A	19	82A	19	165A
	kW	16	23A	15	65A	15	130A
Cont.	kVA	17.6	25A	16.6	72A	16.6	144A
	kW	14	20A	13.3	57A	13.3	115A
Phase		3		1			
Frequency		50Hz					
pf		0.8					

Serial No. 600011      Fuel Tank Capacity: 120Litres      Stage V  
 MGW Skid : 825KG  
 MGW Road Trailer : 951KG  
 Generator Class : G2

Year: 2021

info@stephill-generators.co.uk      www.stephill-generators.co.uk      **CE**

Fig.1

Item No.	Description
1	Generator model type
2	AC voltage output(s)
3	Standby rated power, kVA & kW
4	Continuous prime rated power, kVA & kW
5	Number of phases
6	Rated output frequency
7	Power factor
8	Unique serial number
9	Year of manufacture
10	Relevant maximum current ratings, amps
11	Total fuel tank capacity
	Generator performance class
	MGW - Mass Gross Weight(s)
12	CE mark indicates the generator meets the directives listed on the Declaration of Conformity

## Specification

Specification	Model Type		
	SSDK12(M)	SSDK16(M)	SSDK20(M)
Standby Power (ESP) - 3Ph	13.5kVA / 10.8kW	15.9kVA / 12.7kW	19.0kVA / 15.2kW
Cont. Power (COP) - 3Ph	12.0kVA / 9.6kW	14.5kVA / 11.6kW	17.3kVA / 13.8kW
Standby Power (ESP) - 1Ph	12.6kVA / 10.1kW	14.9kVA / 11.9kW	17.5kVA / 14.0kW
Cont. Power (COP) - 1Ph	11.1kVA / 8.9kW	13.5kVA / 10.8kW	16.0kVA / 12.8kW
Frequency	52.5 - 50.0 Hz	50.0 Hz	50.0 Hz
Voltage	400V / 230V & 115V AC		
Phase	3 Ph / 1 Ph		
LWA	85	88	89
dBA @ 7M	60	63	64
Fuel Tank Capacity	120 Litres		

**(ESP) Standby Power:** Applicable for supplying power to varying electrical load for the duration of power interruption of a reliable utility source in accordance with ISO 8528-1 under the agreed operating conditions with the maintenance intervals and procedures being carried out as prescribed by the manufacturers.

**(COP) Continuous Power:** Applicable for supplying power to electrical load for unlimited hours in accordance with ISO 8528-1 under the agreed operating conditions with the maintenance intervals and procedures being carried out as prescribed by the manufacturers.

### AC Output Protection

As standard all SSDK-Range Stephill generators are configured as a multiphase generator with both single phase (1Ph) and three phase (3Ph) outputs.

#### 400V 3Ph

MCB overload/short circuit protection - RCD earth leakage protection.

#### 230V 1Ph

MCB overload/short circuit protection - RCD earth leakage protection - Thermal reset button overload protection for each socket.

#### 115V 1Ph

Thermal reset button overload protection for each socket.

#### Note

MCB = Miniature Circuit Breaker

RCD = Residual Current Device

All are suitably rated for the generator model type.

### AC Output Earthing Method

**400V 3Ph** - Neutral (star point) bonded to earth.

**230V 1Ph** - Neutral bonded to earth.

**115V 1Ph** - Floating earth.

Running Hours	Model Type		
	SSDK12(M)	SSDK16(M)	SSDK20(M)
25% Load	133 hours @ 0.9 L/h	109 hours @ 1.1 L/h	86 hours @ 1.4 L/h
50% Load	67 hours @ 1.8 L/h	54 hours @ 2.2 L/h	43 hours @ 2.8 L/h
75% Load	41 hours @ 2.8 L/h	34 hours @ 3.5 L/h	26 hours @ 4.6 L/h
100% Load	32 hours @ 3.7 L/h	27 hours @ 4.4 L/h	21 hours @ 5.6 L/h

Engine	SSDK12(M)	SSDK16(M)	SSDK20(M)
Type	Kubota V1505	Kubota D1703	Kubota V2203
Emissions Certification	EU Stage V		
Cylinders	4	3	4
Cooling	Water Cooled		
Displacement	1498cc	1647cc	2197cc
Rpm	1500		
Net Engine Power	Standby 12.5kWm	Standby 14.5kWm	Standby 17.0kWm
	Continuous 11.1kWm	Continuous 13.2kWm	Continuous 15.5kWm

AC Alternator	SSDK12(M)	SSDK16(M)	SSDK20(M)
Type	Meccalte ECP28-3S4 C	Meccalte ECP28-L4 C	Meccalte ECP28-VL4 C

Dimensions & Weights	SSDK12(M)	SSDK16(M)	SSDK20(M)
<b>Skid Mounted</b>	Length 1800mm	Width 800mm	Height 1270mm
Weight - Dry	592 KG	693 KG	731 KG
Weight - Wet	686 KG	787 KG	825 KG
<b>Road Trailer Mounted</b>	Length 3405mm	Width 1335mm	Height 1510mm
Weight - Dry	734 KG	819 KG	857 KG
Weight - Wet	828 KG	913 KG	951 KG

## Control Panel Identification

Fig.2 shows a typical standard multiphase control panel configuration found on all K-Range Stephill generators.

The control panel is made up of engine and generator controls (DC) and the generator output (AC).

Below in Fig.3 & Fig.4 are close-up details of the components found on this control panel.



Fig.2

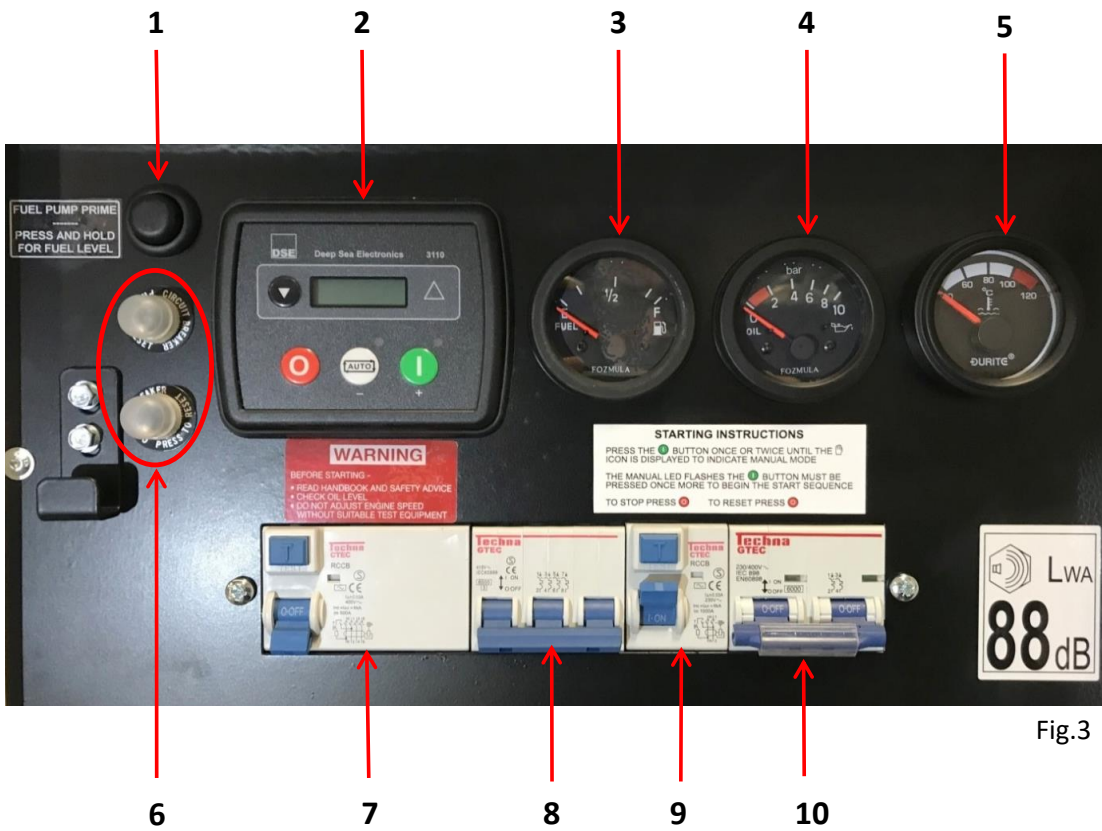

Fig.3

Item No.	Description
1	Fuel Pump Prime Button
2	DSE 3110 Control Module
3	Fuel Gauge
4	Oil Gauge
5	Temperature Gauge

Item No.	Description
6	1A Reset Button (top) - AC 2A Reset Button (bottom) - DC
7	400V 3Ph 4 Pole RCD
8	400V 3Ph 3 Pole MCB
9	230V 1Ph 2 Pole RCD
10	230V 1Ph 2 Pole MCB



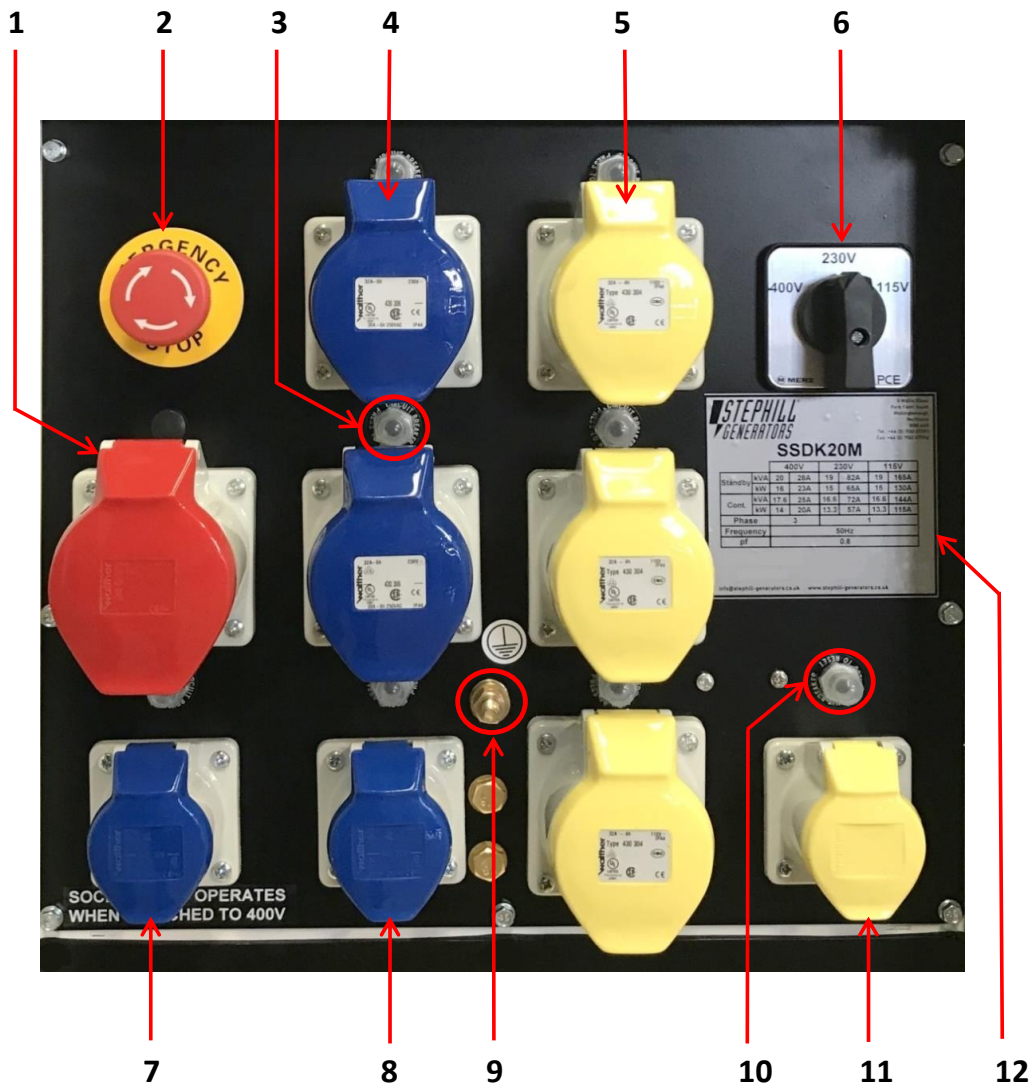

Fig.4

Item No.	Description
1	400V 32A 3Ph Socket Outlet
2	Emergency Stop
3	30A Reset Button - Fitted to all 32A 1Ph socket outlets.
4	230V 32A 1Ph Socket Outlet
5	115V 32A 1Ph Socket Outlet
6	Voltage Selector Switch



Item No.	Description
7	230V 16A 1Ph Socket Outlet (only operates in 400V setting)
8	230V 16A 1Ph Socket Outlet
9	Brass Earth Stud
10	16A Reset Button - Fitted to all 16A 1Ph socket outlets.
11	115V 16A 1Ph Socket Outlet
12	Serial/Data Plate

## Generator Safety

Before using this equipment and to avoid personal injury, all warnings shown on the machine should be observed. The warning signage should be checked for legibility and any that have become damaged should be replaced.

Carefully read and understand the instructions provided. If there is anything you do not understand DO NOT attempt to use this generator. Contact your supplier for advice.

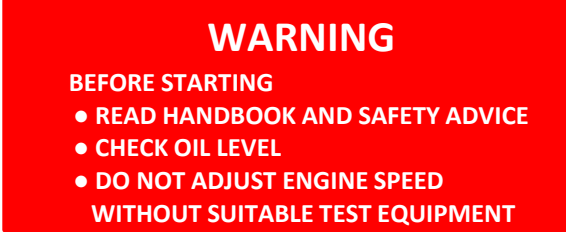
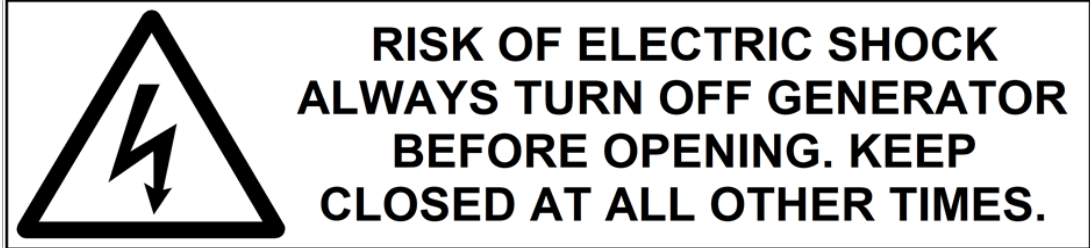
### Warning Signage

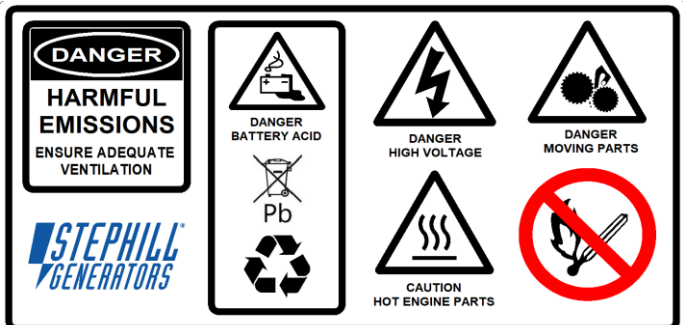
- a)  a) Located behind the control panel cover near the DSE 3110 control module.
- b)  b) Located on both main canopy doors.
- c)  c) Located on the engine end of the canopy near the exhaust outlet.
- d)  d) Located on top of the canopy near the coolant filler flap for the radiator access.
- e)  e) Located near the control panel.

f)

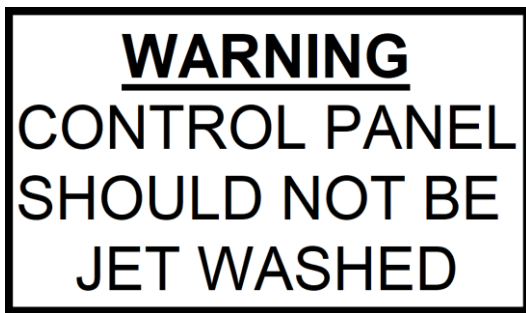

f) Located near the control panel.

g)

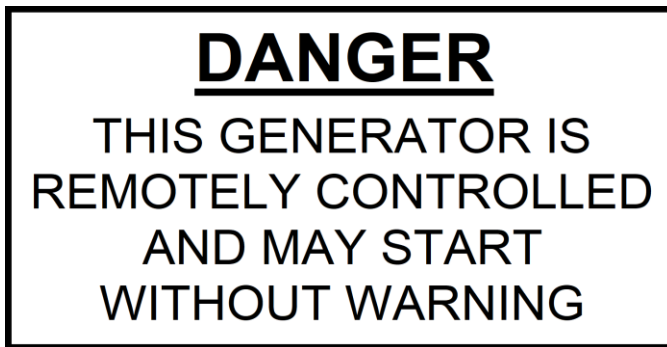

g) Located near the control panel.

h)



h) Located below the control panel.

### Personal Safety

- Do not climb on the generator - dents may cause overheating of the acoustic lining.
- Do not cover the generator as this can obstruct air inlet and outlets on the canopy which can cause the generator to overheat and cause permanent damage..
- Keep well clear of any moving parts on the generator at all times.
- Keep children and pets away from the generator and operating area.
- Test safety features often, emergency stop button and RCD (residual current device).
- Keep the generator canopy doors shut while running and locked if possible.

### Auxiliary Power

The electricity produced by an engine driven generator is very similar to mains AC electricity and should be treated accordingly.

Do not remove covers and attempt to work on the generator while the engine is running.

Check the rating and electrical safety of the load before connecting the generator.

Equipment should never be connected that in total exceeds the specified rating of the generator.

Installation of the generator as a standby or secondary power source should only be undertaken by a fully qualified electrician using the appropriate means of isolation from the mains supply. Installation must comply with all applicable laws, electrical codes and wiring regulations.

## Operating Environment

The generator should always be operated on level ground and be able to bear its weight. Ensure the generator canopy is not obstructed to allow cool air to enter the set and hot expelled air to escape.

## Temperature Range

A temperature range between -15°C and +45°C are the normal limits of operation. Operating outside the range will require additional modifications.

## Reference Relative Humidity

The standard reference condition for relative humidity is 30%. Above this value the rated power must be reduced.

## Reference Barometric Pressure

The standard reference condition for total barometric pressure is 1 bar. This corresponds to an altitude of approximately 100m. Above 100m the rated power must be reduced.

## Flammable Environment

Stephill generators must not be used in a flammable environment.

## Saline Environment

Operation of the machine in a saline environment will require additional corrosion protection.

# Safety Considerations

## General

All Stephill generators comply with current EEC directives including:  
2016/1628/EU Non-Road Mobile Machinery (NRMM).  
2014/30/EU The Electromagnetic Compatibility Directive.  
2006/42/EC The Machinery Directive.  
2000/14/EC Noise emission in the environment by equipment for use outdoors.  
2011/65/EU The Restriction of Hazardous Substances Directive.  
EC 1907/2006 REACH.

## Fuel

Fuels and lubricants are a potential source of fire. Be careful not to spill fuel, clean up any spillages. Inhalation or swallowing of diesel should be avoided. If in doubt seek medical advice. All other forms of contact are an irritant and therefore should also be avoided. If skin contact is made wash with soap and water.

## Lubricating Oil

New oil presents no hazard following short term exposure. Lubricants in particular used engine oil, are potentially carcinogenic. Direct contact should always be avoided by wearing suitable rubber gloves when handling them. Used oil should not be allowed to contact the skin. If this does occur, wash off quickly with a proprietary hand cleanser.

## Bunded Fuel Tank

The SSDK-Range generators are fitted with a secondary fuel containment system, a bunded fuel tank. This will require inspecting on a regular basis and drain accordingly. Any liquid drained from the bund/tank must be treated as waste contaminated fuel/oil and disposed of correctly.

**Warning** Stephill Generators Ltd stress that the ultimate responsibility for ensuring the generator meets with local/national regulations rests with the user.

## Safe Lifting

Where mechanical assistance is used in lifting machines, ensure the lifting eye is used, and that all components used to lift the machine are within their Safe Working Load (SWL).

The integral lifting beam and associated lifting eye on the generator should be regularly checked for signs of damage or gross corrosion.

All nuts and bolts associated with the lifting beam and eye should be regularly checked for tightness and corrosion.

**DO NOT ATTEMPT TO LIFT THE GENERATOR WITHOUT PRIOR CHECKS TO THE LIFTING SYSTEM AS INDICATED ABOVE**

Lifting equipment should never be attached directly to the engine and/or alternator to fully lift the generator except only if lifting engine and/or alternator.

## Earth Connection

All Stephill products are fitted with an earth stud on the control panel this must be connected to an earthing system or spike. Any earth spike required is dependant on the local conditions of use. The size is determined by reference to current IEE regulations or to a competent electrician.

## Fumes

Make sure that the Generator is at least 2 metres away from any building during operation. Operate in a well ventilated unconfined area, so that fumes can be properly dispersed. Silencer outlet should be facing an open area to prevent fumes being recirculated. There is the danger of asphyxiation due to exhaust gases.

Inhalation of poisonous exhaust fumes can lead to serious injury or death. The generator must not be used in a poorly ventilated or enclosed area.

## Noise

Ear protection may be required depending on the combined noise level of the Generator, auxiliary load and the operator's distance from it and the length of exposure. (Noise at Work Regulations 1989)

## Battery Acid

This is corrosive and irritant by all forms of exposure. If skin contact is made wash with clean water.

## Fire

Ensure that suitable fire extinguishers (AFFF or CO2) are kept within close proximity of the generator. Do not cover, enclose, or obstruct the airflow to the generator during or shortly after use, due to fire hazard or damage to the generator from overheating. Allow the generator to cool after use before storing away. Keep all inflammable objects clear of the generator.

## Hot Parts

There is the danger of burns as parts of the generator will become very hot during use. No part of the engine, alternator or exhaust must be touched during or shortly after operation. Do not operate the generator unless all guards are in place. There is a risk of burns or serious mechanical injury.

## Operating Instructions

**STEPHILL GENERATORS LTD STRESS THAT THE ULTIMATE RESPONSIBILITY FOR THE SAFE USE OF THE GENERATOR RESTS WITH THE USER.**

### Pre-start Checks

Before any attempt to start the generator please follow these important guidelines.

#### Check Battery Isolator Key - Location

The 12V battery supply has been fitted with a red "Battery Isolator Key". This is to isolate the 12V battery from the engines 12V DC system when not in use, transportation and when working on repairs/servicing safely.

#### Isolator key location

Open the main canopy door on the control panel side of the generator - Fig.5 & 6



Fig.6

Fig.5

To switch **ON** the 12V battery supply, insert the red key and turn to lock into position.

To switch **OFF** the 12V battery supply, push down and turn the red key counter-clockwise to release.

#### Check Oil Level - How To

It is recommended to check the oil level BEFORE EVERY START OPERATION - Ref. Fig.7 & 8.

Ensure the generator (engine) is on level ground to ensure the correct oil quantity is measured.

- Check the engine oil level before starting or more than 5 minutes after stopping the engine.
- Remove the oil level gauge, wipe it clean and reinstall it.
- Take the oil level gauge out again, and check the oil level.

Fig.7 & Fig.8 show the oil fill and oil dipstick locations for each of the Kubota engines used within the Stephill K-Range generators.

#### SSDK12 - Kubota V1505

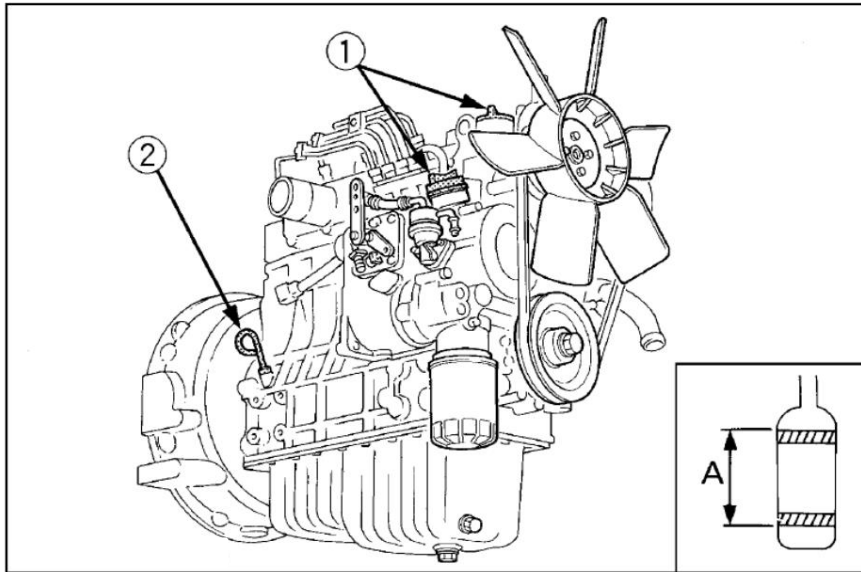

Fig.7

- (1) Oil filler plug(s)  
 (2) Oil level gauge - Dipstick      (A) Ensure the engine oil level within this range

#### SSDK16 - Kubota D1703 & V2003

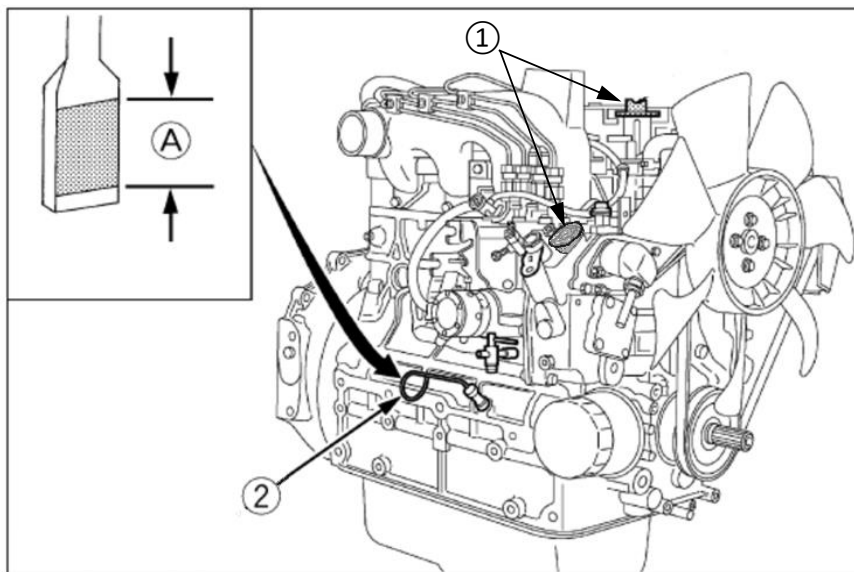

Fig.8

- (1) Oil filler plug(s)  
 (2) Oil level gauge - Dipstick      (A) Ensure the engine oil level within this range

### Adding Engine Oil

Add oil if the level is low. Do not fill past the high mark on the dipstick (2). **WARNING** - Never overfill the engine with oil. Engine damage can occur.

Refer to engine owners handbook supplied with each generator for oil specification, viscosity and typical capacity. Alternatively navigate to the **Service** section at [www.stephill-generators.co.uk](http://www.stephill-generators.co.uk)

## Check Coolant Level

It is recommended to check the water/coolant level of the radiator BEFORE EVERY START OPERATION - Ref. Fig.9.

The radiator is provided with a recovery tank (expansion vessel), check the water/coolant is between the "FULL" and "LOW" marks - Ref. Fig.9.

Refer to engine owners handbook supplied with each generator for further information.

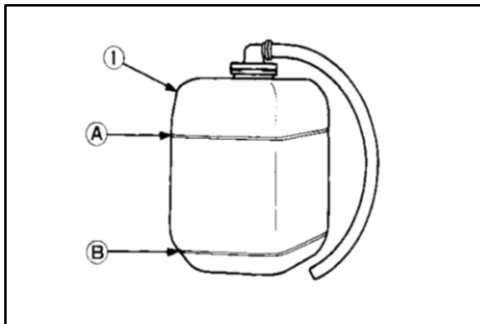

Fig.9

(1) Recovery tank  
(expansion vessel)

(A) "FULL"  
(B) "LOW"

## Check Fuel Level

While the generator is at standstill you will notice the fuel gauge on the control panel will be showing empty "no fuel".

To check the fuel level in the generator fuel tank you can *energise* the fuel gauge by **pressing and holding** the *fuel pump prime button* on the control panel - see Fig.2 & 3.

While holding down the fuel pump prime button you should be able to see the gauge needle rise and rest to indicate a level, also you should hear the fuel pump operating.

## Control Panel Checks



Ensure the all main MCB's are in the "OFF" position (switch down) - Ref Fig.3. **WARNING** - Never try to start the generator with load connected.

## Starting the Generator - Manual Start



This is a basic operation guide, refer to the **DSE 3110 Control Module - Overview** within this handbook for an in-depth view/use of the DSE 3110 control module.

Once all the **pre-start checks** have been made you can then start the generator. Follow the procedure below:



Press the  button until the  is displayed on the LCD screen.

A red LED flashes above the  button.

Press the  button once more, the  icon rotating will be displayed on the LCD screen. This will continue to rotate for approximately 10 seconds. The generator will then crank and start.



## Applying Load

Now the generator is ready to receive load. Select the desired AC voltage with the AC voltage switch.

Plug the load into the relevant AC voltage socket on the control panel.

Switch the main MCB to "ON" (switch up) position on the control panel.

## Stopping the Generator - Manual Stop

Before stopping the generator it is recommended to **switch off the load** from the generator by switching the main MCB on the control panel to the "OFF" position (switch down).

You can then safely stop the generator.

Press the  button and the generator will immediately stop.

## Emergency Stop

The *Emergency Stop* button is located on the control panel. It must **ONLY** be used for emergencies only.

**Warning** Using the Emergency Stop button regularly for a standard stop request can cause the 12V battery to drain. This may effect the starting of the generator.

The  icon will be displayed on the DSE 3110 module when an *Emergency Stop* request is made.

## Remote Start/Stop - 2-wire

The DSE 3110 control module has a 2-wire Remote Start/Stop function. This is a volt free connection, closing two contacts will start and allow the generator to run. Open the contacts and the generator will stop and the DSE 3110 module will wait for the next start request.

## 2-Wire Remote and ATS Auto Start/Stop Connection Location

Below the main control panel is a "HARD WIRE" facility. Once the black plate has been removed there is a small push-on connector block for the remote and auto start/stop connections. Refer to the DC wiring diagram at the back of this handbook or corresponding ATS handbook for the relative terminal positions - Fig.10 & 11.

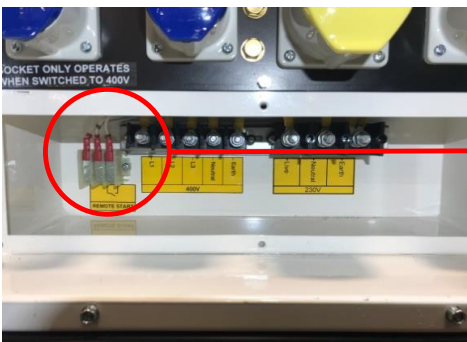

Fig.10



Fig.11

Once the correct connections have been made to the remote start terminals the DSE 3110 control module will require activating to an **AUTO MODE** - See - *DSE 3110 Control Module - Overview* . It will then be ready to accept a remote start request.

## Hard Wire Terminals - Connection & Location

Below the main control panel is a "HARD WIRE" facility. Once the black plate has been removed you will see both the 230V single phase and 400V three phase terminal connections - Fig.12. Yellow labels under the terminal connections indicate the connections - Fig.13.

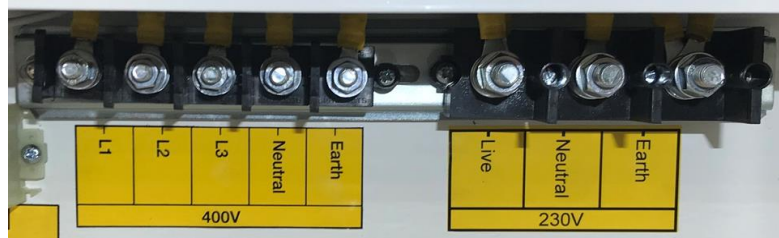

Fig.13

Fig.12

When connecting to the hard wire terminals ensure the cable and crimps are the correct size. If unsure seek advice from a qualified electrician.

400V - M6 threaded stud - Maximum tightening torque to 6.8Nm.

230V - M8 threaded stud - Maximum tightening torque to 16.5Nm

Use the black plate to mount cable gland(s) to secure the trailing cable into position.

**Warning** The plate MUST be fitted when running the generator - Risk of Electric Shock.

## Long Term Storage

For storage or long periods of inactivity, Stephill Generators recommend the following:

Generators should be stored with oil filled to the correct capacity; Storage periods of 18 months and over may require special lubricants and treatments. If so please seek further advice from the engine manufacturer.

Before the generator is used after long term storage, all fuels and oils should be replaced.

Generator mounts, pipes and hoses should be checked to ensure that they are un-perished following extended periods of storage.

The generator should be stored in a clean dry area, ideally having a reasonable constant ambient temperature, and ideally not below freezing.

The battery isolator switch should be switched off.

## DSE 3110 Control Module - Overview

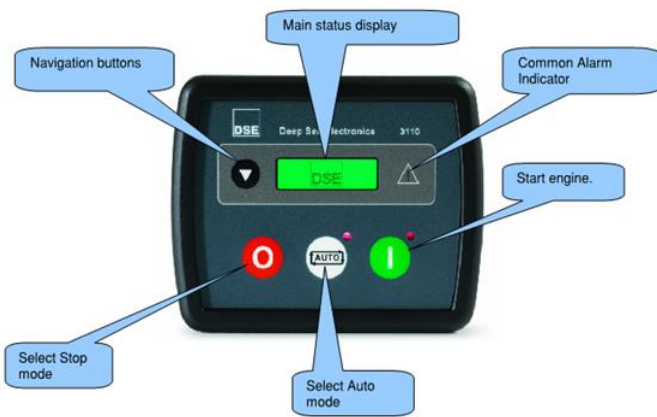

Fig.14

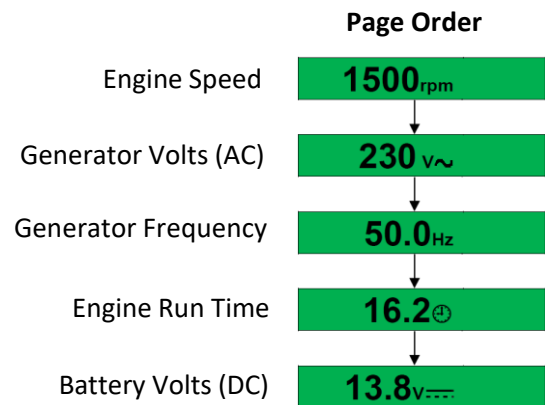

Fig.15

### DSE 3110 Operation

The DSE 3110 control module fitted to the SSD10000S is used to start/stop and monitor key elements of the engine and main AC alternator. Fig.14 show the layout and control buttons.

### Starting Sequence

Once a start request is made the DSE 3110 will energise the *pre-heat* relay over a period of 10 seconds. Then the DSE 3110 will then attempt to crank the engine by operating the starter motor relay and also the fuel pump relay.

When the engine fires, the starter motor is disengaged. (The DSE 3110 de-energises the starter motor relay once it detects an output frequency (Hz) from the main alternator).

If the engine fails to fire during this cranking attempt then the starter motor is disengaged for the crank rest duration after which the next start attempt is made.

Should this sequence continue beyond 3 attempts, the start sequence will be terminated and the **Failed to Start** icon is displayed on the LCD screen.



**Failed to Start**

(See Fault Finding - DSE 3110)

### Timer Icon

When the module is controlling the engine (starting and stopping) an animated (rotating) timer icon will be displayed in the icon area to indicate that a timer is active, for example cranking time, crank rest, stopping



**Timer Icon**

### Engine Running

Once the engine is running and all starting timers have expired, the animated icon is displayed.



**Engine Running**

## Viewing the Instruments

It is possible to scroll to display the different pages of information by repeatedly operating the navigation button.





Fig.15 (above) shows the page order when pressing the navigation button.

Once selected the page will remain on the LCD display until the user selects a different page or after an extended period of inactivity, the module will revert to the status display.

When scrolling manually, the display will automatically return to the Status page if no buttons are pressed for the duration of the LCD Page Timer.

## AUTO MODE - Start/Stop Operation

Activate auto mode by pressing the  button. The  icon will be displayed on the LCD screen to indicate the DSE 3110 module is in **AUTO MODE** if no alarms are present.

A red LED light will be illuminated above the  button.

The generator is now ready to receive start/stop requests from the remote connections.

## Waiting in AUTO MODE

While the DSE 3110 module is in **AUTO MODE** the LCD screen will be permanently illuminated and it will **not** go into any power saving or sleep modes.

If the module is left in **AUTO MODE** for extended long periods of time without running the generator it could flatten the generator battery.

It is advised to have a mains 12V battery charger fitted to the generator battery in most cases of occasional use fixed positioned generators or ensure the generator is started and allowed to continuously run for a minimum of 1 hour once a week.

## External Fuel Source

### 3-Way Valve(s)

As a standard feature the K-Range model generators come fitted with fuel (3-way) valves to manually switch between the generators own internal fuel tank and an external fuel source.

There are two valves, one is to FEED the engine fuel. The other valve is a RETURN, for fuel returning from the engine back to the fuel source.

Both valves must be used in the same position, either in LOCAL (generator fuel tank) or REMOTE (external fuel source).

Both valves connections can be found on the outside of the main generator canopy next to the fuel filler - Fig.16. Yellow labels indicate the valve identity, FEED or RETURN. Another yellow label shows the valve operation.

Fig.17 shows the 3-way valves on the inside of the canopy. They are both currently shown in the LOCAL position.



Fig.16



Fig.17

The size of the hose/pipe connections as shown in Fig. 16 on the outside of the canopy are 1/4" BSP.

### Standard 12V Lift Pump

The engine is fitted with a lift pump for fuel delivery but this is not capable of lifting fuel above a 500mm head. It is therefore advisable to have the remote fuel tank at a higher level than the generator fuel tank to allow gravity feed to the lift pump.

It is recommended that the external fuel source should be as close to the generator as possible. Ensure the hoses/pipes from the external fuel source are kept to a reasonably short length.

All the pipes/hoses and fittings used must be in good condition and of sound quality to ensure the engine runs smoothly and reduce the risk of a fuel leak/spillage - See - **Safety Considerations - Fuel.**

It may be possible to have a remote fuel pump with a bypass valve fitted from the external fuel source. This is useful if the external fuel source cannot be placed near the generator.

### Up-rated 12V Lift Pump

An alternative method to help pull the fuel from an external fuel source to the engine is to uprate the standard 12V fuel lift pump on the engine. Stephill Generators can supply a replacement fuel lift pump that has head lift of around 1.5M.

This is particularly useful if the external fuel source is below the generator or the fuel tank has a depth over 1M. Contact Stephill Generators for more details.

## Fault Finding

**STEPHILL GENERATORS LTD STRESS THAT THE ULTIMATE RESPONSIBILITY FOR THE SAFE USE OF THE GENERATOR RESTS WITH THE USER.**

### Monitoring Systems

All standard Stephill K-Range generators use a **DSE 3110** control module to operate/monitor the engine and generator.

The **SSDK16** & **SSDK20** also have a separate **Engine Control Unit (ECU)**. Both of the above systems can shut down the generator independently. The **SSDK12** only uses a **DSE 3110** control module.

Most common faults/issues can be identified by the fault icon displayed on the **DSE 3110** LCD screen. The table below shows a fault icon and/or the relevant possible causes and checks.

If the **ECU** has detected an issue with the engine (SSDK16 & SSDK20 only) this could also shut the engine down. Any shut down that the **ECU** has issued will be immediately identified by a blinking pattern shown on the ECU fault lamp found on the engine loom - See below.

### Before Fault Finding



We strongly advise before attempting any fault finding is to check the health of the generator battery. It should measure around 12.4 to 12.6 Volts DC while the generator is at standstill.





Be aware of the service/maintenance schedule of the engine, ensuring the fuel filters are replaced regularly along with the oil topped up and oil filter etc. - See - **Service and Maintenance**

Before carrying out any checks ensure all **Load** is unplugged from the generator and be aware of any potential exposed **Live** terminals while the generator is running! All checks and tests should only be carried out by a competent engineer - Ref. **DC wiring diagram**



### Fault Finding - DSE 3110

Fault Icon	Possible Cause	Check
 <p><b>Fail to Start</b> Is activated after three attempts to start.</p> <p><i>Continued</i></p>	Engine <u>Not</u> Starting/Running - Starter motor not engaging	
	Battery	<ul style="list-style-type: none"> <li>Check the battery voltage, should be around 12.5V DC - Charge or Replace.</li> <li>Check the condition of the battery leads.</li> </ul>
	Negative / Ground Connections	<ul style="list-style-type: none"> <li>Check No.1 wires on the control panel and engine DC loom(s) have a sound connection to battery negative.</li> </ul>
	Emergency Stop Button	<ul style="list-style-type: none"> <li>Check the operation of the switches on the back of the emergency stop button.</li> </ul>
	Starter Motor Relay	<ul style="list-style-type: none"> <li>Check the operation and wiring of the starter motor relay - Replace if necessary.</li> </ul>
	Fuse	<ul style="list-style-type: none"> <li>Check the 30A fuse on the engine loom - <b>Ref. wiring diagram.</b></li> </ul>

Fault Icon	Possible Cause	Check	
 <p><b>Fail to Start</b> Is activated after three attempts to start</p>	DSE 3110 Control Module	<ul style="list-style-type: none"> <li>• Check the plugs on the back of DSE 3110.</li> <li>• Check for battery + output at No.4 (starter motor relay feed) after the pre-heat time - <b>Ref. wiring diagram.</b></li> </ul>	
	Starter Motor	<ul style="list-style-type: none"> <li>• Check the operation and wiring of the starter motor - Replace if necessary.</li> </ul>	
	<b>Engine Not Starting/Running - Starter motor engaging but engine not starting</b>		
	Fuel Filter(s)	<ul style="list-style-type: none"> <li>• Check in-line fuel filter and replace if necessary.</li> <li>• Check and/or replace the main fuel filter.</li> </ul>	
	Fuel Lift Pump (12V DC)	<ul style="list-style-type: none"> <li>• Check the fuel pump is receiving 12V DC and is operating - Replace if necessary.</li> </ul>	
	Air Filter	<ul style="list-style-type: none"> <li>• Check the condition of the air filter - Replace if necessary.</li> </ul>	
	Contaminated Fuel	<ul style="list-style-type: none"> <li>• If possible run the generator from a separate fuel source from the fuel tank.</li> </ul>	
	If none of the above solve the issue then a closer inspection of the engine would be advised e.g. injector etc. - Consult an engine specialist.		
	<b>Engine Starting/Running Then Stopping - 3 Attempts DSE 3110 not showing Volts or Hz when running?</b>		
	2A Reset Button	<ul style="list-style-type: none"> <li>• Check for continuity and wiring on the AC 2A reset button (brown wire from DSE 3110) - Replace if necessary.</li> </ul>	
DSE 3110 Control Module	<ul style="list-style-type: none"> <li>• Check the green plug with a brown &amp; blue wire is not loose.</li> <li>• Start and run the generator and measure the AC voltage across the brown &amp; blue wires - this should measure approximately 115V or 230V AC.</li> </ul>		
Main AC Alternator	<ul style="list-style-type: none"> <li>• Check main alternator output - AC alternator tests would be advisable.</li> </ul>		
 <p><b>Emergency Stop</b></p>	Emergency Stop Button	<ul style="list-style-type: none"> <li>• Check if the emergency stop button has been activated.</li> <li>• Check the switches function and wiring on the back of the emergency stop.</li> </ul>	
	DSE 3110 Control Module	<ul style="list-style-type: none"> <li>• Check that all the green plugs are fitted correctly and the wiring.</li> </ul>	
 <p><b>Low Hz/Frequency Shutdown</b></p>	The <b>SSDK12</b> Kubota engine (V1505) has an adjustable governor that can increase and decrease the engine speed. This is factory set by Stephill during testing. <b>It is not recommended to adjust the engine speed unless absolutely necessary</b> - The correct <b>no-load</b> frequency for this engine is <b>52.5Hz</b> .		
	The Kubota engines on both the <b>SSDK16 &amp; SSDK20</b> use an engine speed sensor that is operated via the ECU. This keeps the engine speed/frequency constant at <b>50.0Hz</b> on and off load.		
	<b>Low Hz/Frequency could indicate the engine is running too slow.</b>		
	Fuel Filter(s)	<ul style="list-style-type: none"> <li>• Check in-line fuel filter and replace if necessary.</li> <li>• Check and replace the main fuel filter if necessary.</li> </ul>	
	Air Filter	<ul style="list-style-type: none"> <li>• Check the condition of the air filter - Replace if necessary.</li> </ul>	
	Fuel Lift Pump (12V DC)	<ul style="list-style-type: none"> <li>• Check the fuel pump is receiving 12V DC and is operating - Replace if necessary.</li> </ul>	
	Contaminated Fuel	<ul style="list-style-type: none"> <li>• If possible run the generator from a separate fuel source from the fuel tank.</li> </ul>	
If none of the above solve the issue then a closer inspection of the engine would be advised e.g. check that no-one has adjusted the engine speed - consult an engine specialist.			

Fault Icon	Possible Cause	Check
 <b>High Hz/Frequency Shutdown</b>	High Hz/Frequency could indicate the engine is running too fast.	
	Fuel System	<ul style="list-style-type: none"> <li>Using the fuel pump prime button, prime the fuel system to expel any trapped air within.</li> </ul>
If none of the above solve the issue then a closer inspection of the engine would be advised e.g. check that no-one has adjusted the engine speed - consult an engine specialist.		
 <b>Low AC Voltage Shutdown</b>	The DSE 3110 is displaying the correct no-load frequency but the generator shuts down with the <b>Low AC Voltage</b> icon displayed.	
	2A Reset Button	<ul style="list-style-type: none"> <li>Check for continuity and wiring on the AC 2A reset button (brown wire from DSE 3110) - Replace if necessary.</li> </ul>
	DSE 3110 Control Module	<ul style="list-style-type: none"> <li>Check plug with a brown &amp; blue wires is not loose.</li> <li>Start and run the generator and measure the AC voltage across the brown &amp; blue wires - this should measure approximately 115V or 230V AC.</li> </ul>
	Main AC Alternator	<ul style="list-style-type: none"> <li>Check main alternator output - AC alternator tests would be advisable.</li> </ul>
Automatic Voltage Regulator - AVR	<ul style="list-style-type: none"> <li>Check all wiring and circuits associated with the AVR.</li> </ul>	
 <b>High AC Voltage Shutdown</b>	The DSE 3110 is displaying the correct no-load frequency but the generator shuts down with the <b>High AC Voltage</b> shutdown icon displayed.	
	Main AC Alternator	<ul style="list-style-type: none"> <li>Check main alternator output - AC alternator tests would be advisable.</li> </ul>
	Automatic Voltage Regulator AVR	<ul style="list-style-type: none"> <li>Check all wiring and circuits associated with the AVR.</li> </ul>
 <b>Fail To Stop</b>	A <b>Fail To Stop</b> fault is mostly caused by the oil pressure switch not operating correctly - See the <b>Service &amp; Maintenance</b> section in this handbook for a detailed solution.	
	Oil Pressure Switch	<ul style="list-style-type: none"> <li>Check the oil pressure switch operation - Switch normally closed when engine is at rest and open when engine running - Remove, clean or replace if necessary.</li> </ul>
	Faulty Wiring	<ul style="list-style-type: none"> <li>Check wiring from the oil pressure switch to the DSE 3110 - Ref. wiring diagram.</li> </ul>
	Service	<ul style="list-style-type: none"> <li>Oil change and oil filter replaced highly recommended.</li> </ul>
 <b>High Engine Temperature</b> Fault occurs after the engine has fired	A <b>High Engine Temperature</b> shutdown could be for two main reasons, either the engine has overheated or the temperature switch or wiring is faulty.	
	Coolant Level	<ul style="list-style-type: none"> <li>Check the level of the water and antifreeze level - fill with a 50/50 mix as indicated by the sticker next to the inspection flap. <b>CAUTION HOT STEAM CAN BURN!</b></li> </ul>
	Radiator	<ul style="list-style-type: none"> <li>Check the radiator fins are not obstructed/dirty.</li> <li>Check the radiator is not damaged or leaking coolant.</li> </ul>
	Fan Belt	<ul style="list-style-type: none"> <li>Check the condition and tension of the fan belt - tighten or replace if necessary.</li> </ul>
	Canopy Obstructions	<ul style="list-style-type: none"> <li>Check the generator canopy has no obstructions over any vented areas - Also see <i>Operating Environment</i> in this handbook.</li> </ul>
	Temperature Switch	<ul style="list-style-type: none"> <li>Check the temperature switch operation - Ref. wiring diagram - replace if necessary. <b>DO NOT USE THE GENERATOR WITHOUT A TEMPERATURE SWITCH FITTED.</b></li> </ul>
	Faulty Wiring	<ul style="list-style-type: none"> <li>Check associated wiring from the temperature switch to the DSE 3110 - Ref. wiring diagram.</li> </ul>
If the temperature gauge shows a high temperature (> 100°C) and the generator is shutting down with all the above checked, then the issue could be an engine component e.g. thermostat, water pump etc. - consult an engine specialist.		



Fault Icon	Possible Cause	Check
 <b>Low Oil Pressure</b> Fault occurs after the engine has fired	Low Oil Level	<ul style="list-style-type: none"> <li>Check oil level and top-up to the correct level if necessary.</li> </ul>
	Oil Pressure Switch	<ul style="list-style-type: none"> <li>Check the oil pressure switch operation - Switch normally closed when engine is at rest and open when engine running - Remove, clean or replace if necessary.</li> </ul>
	Faulty Wiring	<ul style="list-style-type: none"> <li>Check wiring from the oil pressure switch to the DSE 3110 - Ref. wiring diagram</li> </ul>
	Service	<ul style="list-style-type: none"> <li>Oil change and oil filter clean recommended.</li> </ul>
 <b>Charge Fail</b> Battery Flat and/or Not Charging	When the engine is running you should expect the regulated DC voltage measured on the battery to between 13.8 and 14.8V DC	
	Fan Belt	<ul style="list-style-type: none"> <li>Check the condition and tension of the fan belt - tighten or replace if necessary.</li> </ul>
	Battery Terminals/Leads	<ul style="list-style-type: none"> <li>Check the condition and tightness of the battery leads and terminals.</li> </ul>
	Battery	<ul style="list-style-type: none"> <li>Check or change the battery.</li> </ul>
	Faulty Wiring	<ul style="list-style-type: none"> <li>Check continuity of all wires from charge alternator.</li> <li>Check exciter DC voltage from the Deep Sea 3110 when running - Ref. wiring diagram.</li> </ul>

### Fault Finding - Kubota ECU - (SSDK16 - 20)

If the Kubota Engine Control Unit (ECU) detects an issue on the engine it will shutdown the engine after 10 seconds from starting or intermittently. This will often flag up various shutdown alarms on the DSE control module. These could range from *Low Oil Pressure* , *Low Frequency (Hz)* and/or *Low AC Voltage*.

Carry out the "Before Fault Finding" as listed above and using the DSE 3110 control module check the no load AC voltage & frequency displayed on the screen is correct.

**AC Voltage:** Between 110V and 120V or 220V to 240V (dependant on model variant)

**Frequency (Hz):** 50.0 Hz

If it appears that the oil pressure, frequency and AC voltage are satisfactory then this would indicate the ECU is shutting the engine down and not the DSE control module. If so the ECU lamp will blink a shutdown code.

### ECU SHUTDOWN CODE

A RED lamp can be found on the engine wiring harness in the location shown in Fig.18 & Fig.19. The RED lamp will display a blinking pattern via the ECU upon a fault detected and the engine shutting down. The blinking pattern will be relevant to the chart shown below.

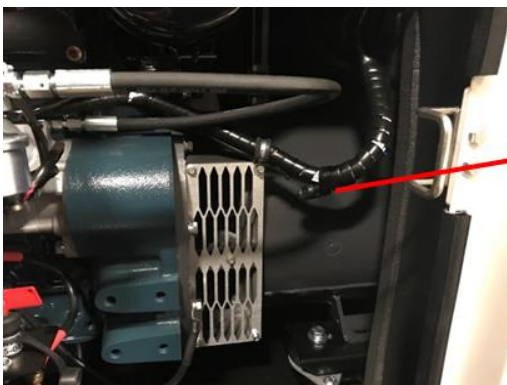















Fig.18



Fig.19

Below are the blinking patterns and the associated fault/issue.

Blinking Pattern of Glow Lamp	Cause	Refer to Checking
(1-Long and 1-Short)  3EEAAB1P005A	Overrunning (more than 115 %)	Solenoid
(1-Long and 2-Short)  3EEAAB1P006A	Low oil pressure	Oil sensor
(1-Long and 3-Short)  3EEAAB1P007A	Defect of alternator	Alternator
(1-Long and 4-Short)  3EEAAB1P008A	Coolant temperature is abnormal	Water temperature switch
(1-Long and 5-Short)  3EEAAB1P009A	Emergency stop switch operated	Emergency stop switch
(1-Long and 6-Short)  3EEAAB1P035A	Coolant temperature is abnormal	Water temperature sensor
(1-Long and 7-Short)  3EEAAB1P037A	Starting error	Starter ON > 12 sec
(2-Long and 1-Short)  3EEAAB1P010A	Abnormality of speed sensor	Speed sensor
(2-Long and 2-Short)  3EEAAB1P011A	Solenoid malfunction	Solenoid
(2-Long and 4-Short)  3EEAAB1P012A	Disconnection of water temperature sensor	Water temperature sensor
(2-Long and 5-Short)  3EEAAB1P013A	Short circuit of water temperature sensor	Water temperature sensor
(2-Long and 6-Short)  3EEAAB1P014A	Disconnection of alternator L Terminal	Alternator L Terminal
(2-Long and 7-Short)  3EEAAB1P015A	Over voltage	Alternator
(2-Long and 8-Short)  3EEAAB1P016A	Sensor supply voltage	ECU, Sensor, Wiring Harness

## Fault Finding - General

Fault Description	Checks/Causes
Generator starts and runs but will not take load	<ul style="list-style-type: none"> <li>● Check/test the main MCB and RCD.</li> <li>● Check/test the voltage selector switch.</li> <li>● Check the wiring behind the control panel.</li> </ul>
<p style="text-align: center;"><b>Generator not stopping</b></p> <p>Generator/Engine fails to stop when the <b>Stop</b> button or the <b>Emergency Stop</b> button is pressed.</p>	<ul style="list-style-type: none"> <li>● Check that the engine <i>Stop Solenoid</i> is receiving 12V DC <u>when a stop signal is issued</u> - Ref. wiring diagram. If 12V DC can be measured replace the <i>Stop Solenoid</i> . If <u>no</u> 12V DC can be measured check wiring on/to the <i>Timer Relay</i> and replace the <i>Timer Relay</i> if necessary.</li> </ul>
<p style="text-align: center;"><b>No power to DSE 3110 control module</b></p> <p>The LCD display is not illuminated and module is not responding.</p>	<ul style="list-style-type: none"> <li>● Check that the battery isolator switch is turned to the ON position.</li> <li>● Check the battery lead connections/condition on the battery and to the engine.</li> <li>● Check the battery voltage is around 12.5V DC.</li> <li>● Check the connections on the DC plug and socket.</li> <li>● Check the 2A reset button next to the DSE 3110 - Ref. wiring diagram. Replace if necessary.</li> <li>● Check DC voltage between wires 1 &amp; 2 on the DSE 3110 - Ref. wiring diagram. Replace the DSE 3110 module if necessary.</li> </ul>
<p style="text-align: center;"><b>Fuel gauge not operating</b></p> <p>Fuel level showing empty or full incorrectly.</p>	<p style="text-align: center;"><i>See - Check Fuel Level in Operating Instructions.</i></p> <p style="text-align: center;"><b>Gauge shows empty even with a full fuel tank.</b></p> <ul style="list-style-type: none"> <li>● While the <i>Fuel Pump Prime</i> button is pressed and held down, check 12V DC is present across wires No.33 &amp; No.1 on the back of the <i>Fuel Gauge</i>. :- If 12V DC is measured replace the fuel gauge. :- If no 12V DC can be measured check wiring - Ref. wiring diagram.</li> </ul> <p style="text-align: center;"><b>Gauge shows full even with no fuel in the tank.</b></p> <ul style="list-style-type: none"> <li>● Check the connections at the <i>Fuel Level Sender</i> - Ref. wiring diagram. Measure the resistance between wires No.1 &amp; No.18 on the back of the gauge, this should measure between 10 and 180Ω. If no Ohms can be measured check wiring to <i>Fuel Level Sender</i> . :- If no Ohms reading can be measured at the <i>Fuel Level Sender</i> - replace fuel sender If the resistance and DC voltage at the <i>Fuel Gauge</i> is correct replace the <i>Fuel Gauge</i> .</li> </ul>

## Service and Maintenance

### Pre-service

**Warning** - Do not attempt to carry out any service or maintenance work on the generator whilst the engine is running. Always isolate/disconnect the battery prior to working on the engine or alternator.

### Engine Service

Keeping to the maintenance schedule recommended by the engine manufacture will ensure your generator engine will perform at its optimum efficiency. The benefits of regular servicing will lower the risk of unexpected breakdown considerably and ensure your generator will continue to perform for many years.

Service the engine strictly in accordance with the instructions given in the relevant engine operator manual / handbook. It is recommended that an approved specialist must carry out any maintenance. Any spare parts required should be of genuine manufacturer's origin. See *Spares for Kubota Consumable Service Spares* .

**Note:** Failure to adhere to manufacturer's recommended service schedules may invalidate the warranty. Please consult engine operator's manual for full service intervals. More information is available at [www.kubota-eu.com](http://www.kubota-eu.com)

You can find the basic service intervals at [www.stephill-generators.co.uk](http://www.stephill-generators.co.uk)

### Oil System Service

To ensure both the oil pressure switch and oil pressure sender continue to operate correctly, Stephill Generators recommends that both components may require/benefit from a periodic "service" (annually is recommended).

### Oil System Location(s)

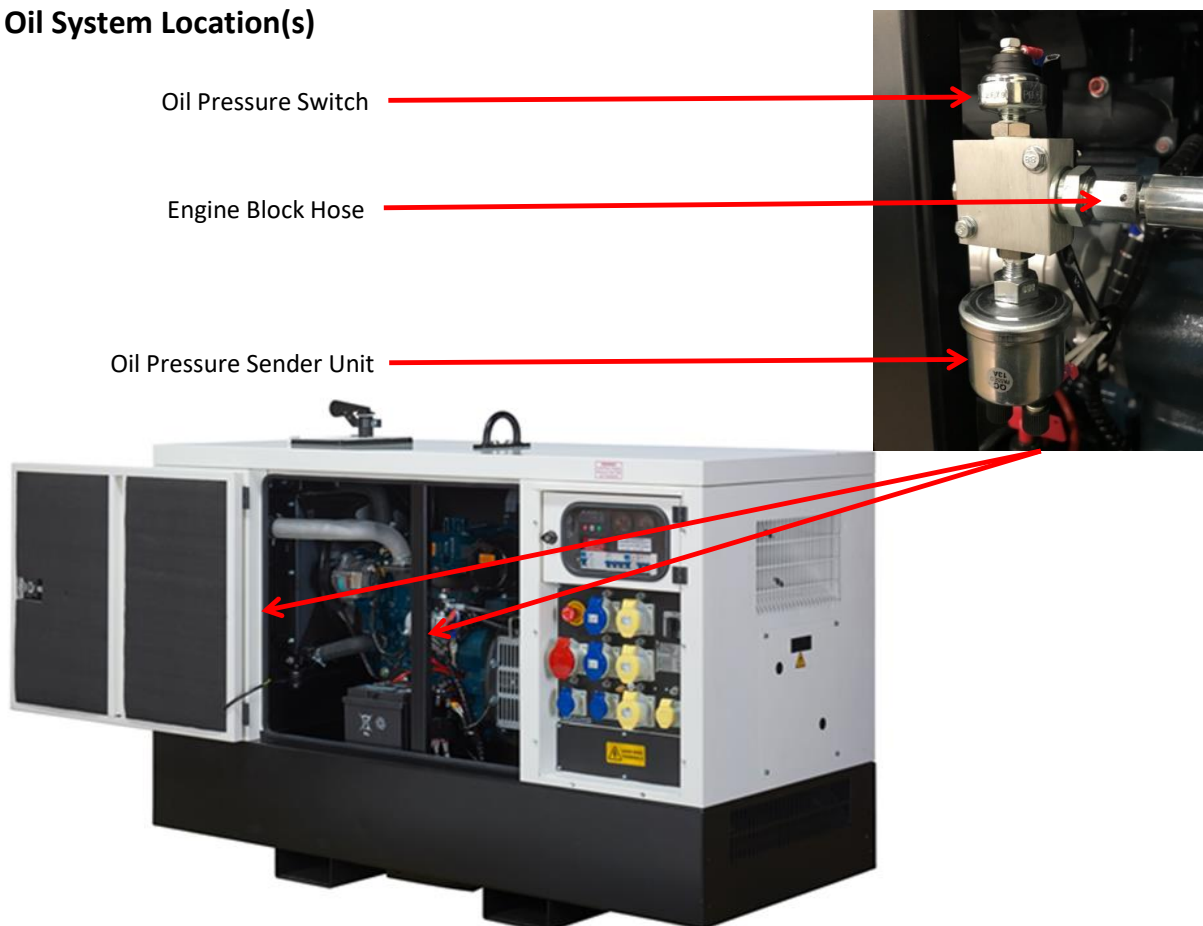

Fig.21

Fig.20

## Oil System Service Procedure

To avoid a potential issue with the generator shutting down or not starting with a "Fail To Stop" icon displayed on the DSE 3110 control module LCD screen (see *Fault Finding - DSE 3110*), the oil system can be cleaned to remove old sticky oil deposits that can sometimes accumulate within the oil system. Referring to Fig.20 & Fig.21, remove the oil pressure switch, oil pressure sender unit and the engine block hose from the assembly. Clean each component with an evaporating cleaning agent e.g. brake cleaner. Lightly tap both the oil pressure switch and sender to loosen and remove any old oil that maybe stuck inside. Re-fit and tighten into position.

## Alternator Service

Brushless alternators employed on Stephill Generators are maintenance free. Service must be carried out by competent qualified personnel strictly in accordance with the instructions given in the handbook. Any spare parts required should be of genuine manufacturer's origin. For further information please consult alternator manufacturer's website. [www.meccalte.com](http://www.meccalte.com)

### **IMPORTANT WARNING**

After any service on the generator, ensure that all piping and electrical cables are correctly routed and secured away from hot parts. Failure to observe this warning may result in damage to the piping and cables which could result in a fire. Do not service or work on generator whilst the engine is running. Always disconnect battery prior to working on engine or alternator.

**STEPHILL GENERATORS LTD STRESS THAT THE ULTIMATE RESPONSIBILITY FOR THE SAFE USE OF THE GENERATOR RESTS WITH THE USER.**

## Road Tow Trailers

Stephill K-Range generators have a road tow trailer option. Stephill K-Range generators fitted to a road tow trailer by Stephill has been type approved for use on the public highway and will have a Vehicle Identification Number (VIN) stamped on the side. Each K-Range generator will also be issued with a trailer Certificate Of Conformity to accompany the VIN.



## Trailer Information

TRAILER TYPE	TYRE SIZE	MAX TYRE PRESSURE	TYRE PLY	MAX TYRE LOAD	TYRE LOAD RATING	WHEEL TORQUE SETTING	COUPLER (EYE/HITCH) TORQUE SETTING	ONE SHOT HUB NUT TORQUE SETTING
AL-KO 1000KG single axle	165 R13	2.5 BAR 36 PSI	<b>Tread</b> 2x Steel 1x Polyester <b>Side</b> 1x Polyester	487Kg	83T	88Nm	86Nm	<b>581200</b> Self Locking Nut

## Safety Precautions

No welding is permitted on the trailer axle.

It is important that the wheel and hub/brake drum are compatible. This means that the PCD, wheel bolts and inset must all be compatible with both the hub/brake drum and the wheel rim. Particular attention must be paid to the recommended torque settings for the wheel bolts.

The axle type details shown on the axle type plates must not be obstructed or made illegible by application of any additional surface finish.

## Wheels

Check the tyre pressure regularly. Incorrect tyre pressure can lead to excessive wear and loss of grip.

M12 wheel bolts. These must always only be tightened to the correct torque setting as shown. They should be tightened in sequence, North, South, East, West and never clock or anti-clockwise. Always use a calibrated torque wrench. It is dangerous to overtighten wheel bolts as it is to not tighten them sufficiently.

The wheel torque settings should be re-checked after 50 km.

The condition of the wheels and tyres should be checked regularly, particularly for distortion of flanges and the wheel dish. Wheels that are damaged or distorted, or have wheel bolt seating's cracked or deformed must not be repaired or used in service - these must be replaced.

## Number Plate

It is a legal requirement to have a industry standard approved rear number plate fitted and clearly displayed on the trailer with reference to the towing vehicle.

The UK industry standard size number plate is 520 mm × 111 mm (20½" × 4¾").

## Hitch Type

Fig.22 & 23 show standard hitch types provided by Stephill Generators.



Fig.22



Fig.23

## Pre-Towing/Hitch-up

Follow the checks below when hitching the generator to a vehicle and before every journey.

1. Ensure the towing vehicle is able to tow the MGW as indicated on the generator data plate.
2. Turn the battery isolator key to "OFF" on the generator - remove key if you wish.
3. Ensure all electrical cables have been disconnected.

4. Make sure all generator canopy doors and inspection doors are closed and locked. Ensure the fuel cap is secure and locked. All loose items that may be on the roof removed, this would include snow and ice in winter.
5. Ensure the hand brake is "ON". Brake lever in the upright position.

### **Important Note**

Please note that when the handbrake is fully applied the trailer is able to move backwards by 25cm until the spring cylinder takes effect.

### **Hitching Method**

1. Using the jockey wheel adjust the height of the hitch/eye to the desired level of the towing vehicle tow bar.
2. Reverse the towing vehicle so it is in line and under the generator towing hitch or the eye sits inside the tow bar recess.
3. **Ball** - Lower the hitch with the jockey wheel on to the tow ball, lifting the hitch handle while lowering until the handle clicks. The green indicator on the hitch will be visible if the hitch has successfully fitted into position. **Eye** - Once the eye has been located into the tow bar recess drop the locking bolt through the tow bar and the eye and attach the retaining clip on the locking bolt.
4. Raise the jockey wheel by turning the handle and ensure the wheel is inline with the draw bar and is off the ground. Release the jockey wheel clamp and raise the jockey wheel up to the draw bar. Re-clamp the jockey wheel into this position.
5. Connect the breakaway cable to the attachment point on the tow bar. Secure either around the hitch tow ball or through the guide provided on the tow bar assembly.
6. Connect the 13-Pin plug to the towing vehicle socket. In some circumstances the plug may require an adaptor to convert the lighting board standard 13-Pin plug to a 7-Pin plug to fit the towing vehicle socket.
7. Double check that the towing hitch or eye is securely fitted to the towing vehicle tow bar, the breakaway cable is fitted and light socket is secure.
8. Release the handbrake. Brake lever in the down position.
9. Before moving off in the towing vehicle check the operation of the lights.

### **Service Brake**

When the towing vehicle is braking or travelling down hill, the overrun device shaft is pushed in (dependent on the magnitude of the thrust on the shaft) and presses on the overrun lever. This acts on the Bowden cables and expander mechanism, which in turn expands the brake shoes applying the wheel brakes.

### **Reversing**

When the towing vehicle is reversing, the overrun device shaft is pushing in and will apply the brakes via the overrun lever brake rod system, Bowden cables and the expander mechanism. The backwards rotation of the brakes drum causes the secondary brake shoe to collapse cancelling out the braking effect, allowing the trailer to move backwards. At the same time the transmission lever swings back and compensates for the entire travel.

**STEPHILL GENERATORS LTD STRESS THAT THE ULTIMATE RESPONSIBILITY FOR THE SAFE USE, SERVICE AND CONDITION OF THE TRAILER IS WITH THE OWNER/USER.**

## Spares

### Kubota Consumable Service Spares

Basic Kubota engines service kits are available from Stephill Generators, below are the individual parts complete with part numbers.

	SSDK12(M)	SSDK16(M)	SSDK20(M)
<b>Description</b>	Kubota V1505	Kubota D1703	Kubota V2203
Oil Filter	015-0028	015-0107	015-0107
Air Filter	015-1004	015-0110	015-0106
Fuel Filter (Main)	015-0029	015-0112	015-0112
Fuel Filter ( In-line)	015-0030		
Fan Belt	015-1008	015-0109	015-0109

### Control Panel - AC Components - Standard Multiphase

Description	Part No.	Description	Part No.
16A 3 Pole MCB (SSDK12)	036-0007	AC Switch 12 Pole 115-230-400V	043-0009
25A 3 Pole MCB (SSDK16)	036-0013	AC Switch Cover - Black Boot	023-1091
32A 3 Pole MCB (SSDK20)	036-0016	115V Socket 16A	044-0001
50A 2 Pole MCB (SSDK12)	036-0021	230V Socket 16A	044-0002
63A 2 Pole MCB (SSDK16)	036-0025	115V Socket 32A	044-0003
80A 2 Pole MCB (SSDK20)	036-0026	230V Socket 32A	044-0004
63A 2 Pole RCD 30mA (SSDK12-16)	036-0029	400v Socket 32A	044-0014
100A 2 Pole RCD 30mA	036-0030	Reset Button 16A	036-0049
40A 4 Pole RCD 30mA	036-0036	Reset Button 30A	036-0052
Hard Wire Terminal M6	038-0102	Dust Cover IP23 Reset Button	036-0056
Hard Wire Terminal M8	038-0103		

### Control Panel - DC Components - Standard Multiphase

Description	Part No.	Description	Part No.
DSE 3110 Control Module	045-0061	40A Maxi blade Fuse (x2 per Pack)	036-0057
DSE 3110 Rubber Gasket	045-0062	60A Maxi blade Fuse (x2 per Pack)	036-0059
Fuel Pump Prime Push Button	045-0006	Fuse Holder	036-0061
Emergency Stop c/w with RED N/C Switch	045-0018	Oil Pressure Gauge 0-10 bar	055-0009
RED N/C Switch (only) to Fit E-Stop	045-0032	Fuel Gauge	055-0010
Relay 4-Pin 30-40A 12V	056-0002	Temperature Gauge	055-0022
Relay 4-Pin 70A 12V (Pre-heat)	056-0003	1A Reset Button	036-0043
Relay Holder 30-40A	056-0005	2A Reset Button	036-0055
Relay Holder 70-100A	056-0004	Dust Cover (1 -2A Reset)	036-0077

### General Spares

Description	Part No.	Description	Part No.
Key FT105	045-0004	Mounts - Engine & Alternator	027-0051
Fuel Filler Cap - Lockable c/w Key	048-0008	Door Seal - Rubber Edging	023-1023
Control Panel Turn Button Lock c/w Key	023-1079	Radiator Inspection Flap Seal	023-1025
Hinge M5 - Control Panel Door	014-1000	Slam Lock Canopy Doors	023-1014
Hinge M8 - Canopy Doors	023-1000	Door Strike/Catch	023-0257
Hinge Plastic - Radiator Flap	023-1029	Fuel Tank - Plastic Moulded	023-0121

cont.



**General Spares - cont.**

Fuel Sender Unit 210mm	023-1082	Fuel Tank Hose 3"	023-1044
Isolator Switch - c/w Red Key - Battery	045-0020	Handle Flush - Radiator Plate	014-1004
Polycarbonate Window - Con. Panel Door	023-0178	Battery 12V 063	054-0004
Window Seal - Rubber	023-1002	Terminal Battery Positive	038-0107
Window Seal Locking Strip	023-1003	Terminal Battery Negative	038-0108

**Engine Accessories**

Description	Part No.	Description	Part No.
3-way Valve Kit - Fuel	023-1040	Temperature Sender (SSDK12)	023-1052
Oil Drain Hose Kit (SSDK12)	023-1035	Temperature Sensor - Kubota (SSDK16-20)	023-0050
Oil Drain Hose Kit (SSDK16-20)	023-1039	12V Fuel Pump	015-0125
Oil Pressure Sender - 0-10 bar	016-1015	Temperature Switch (SSDK12)	015-0008
Oil Pressure Switch - Kubota	015-1003	Temperature Switch (SSDK16-20)	
Engine Loom - Complete (SSDK12)	039-0017	Engine Loom - Complete (SSDK16-20)	039-0017
Engine Foot Brkt Non Service Side (SSDK12)	023-0198	Engine Foot Bracket Right (SSDK16-20)	023-0159
Engine Foot Brkt Service Side (SSDK12)	023-0199	Engine Foot Bracket Left (SSDK16-20)	023-0199

**Exhaust System Spares**

Description	Part No.	Description	Part No.
Silencer V1505 (SSDK12)	023-0134	Silencer (SSDK16-20)	023-0173
Down Pipe V1505 (SSDK12)	023-0116	Down Pipe (SSDK16-20)	023-0133
Manifold Pipe V1505 (SSDK12)	023-0197	Manifold Pipe D1703/V2203 (SSDK16-20)	023-0188
Tail Pipe V1505 (SSDK12)	023-0261	Tail Pipe (SSDK16-20)	023-0212
Rain Flap/Cap (SSDK12)	023-1015	Rain Flap/Cap (SSDK16-20)	023-1016
Fiberglass Manifold Sleeve	023-1098	U-Clamp 48mm	027-0061
U-Clamp 32mm	027-0057	U-Clamp 52mm	027-0062
U-Clamp 42mm	027-0060		

**Note**

All parts are suitable for all SSDK12-25 builds

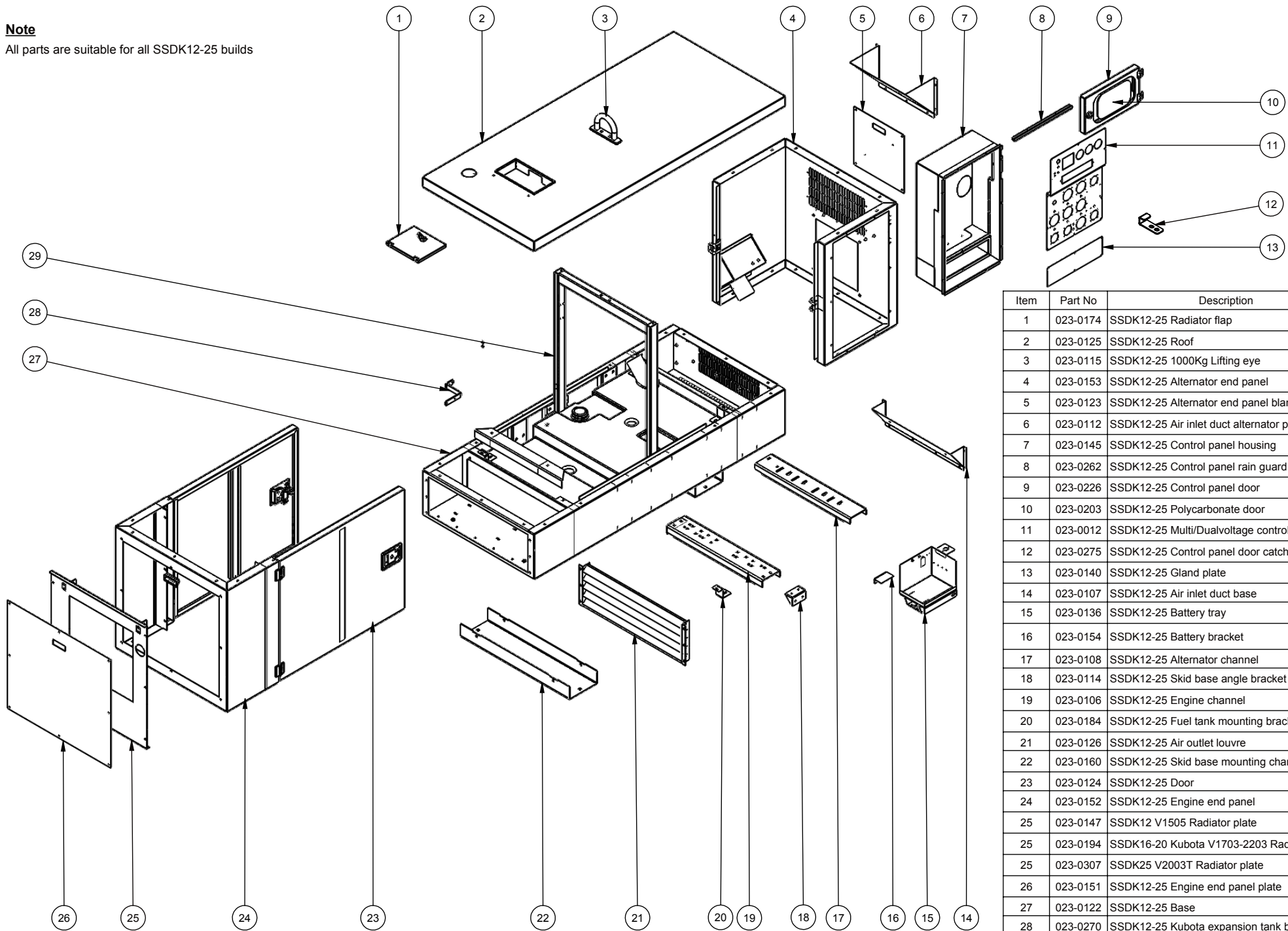

Item	Part No	Description	Qty
1	023-0174	SSDK12-25 Radiator flap	1
2	023-0125	SSDK12-25 Roof	1
3	023-0115	SSDK12-25 1000Kg Lifting eye	1
4	023-0153	SSDK12-25 Alternator end panel	1
5	023-0123	SSDK12-25 Alternator end panel blanking plate	1
6	023-0112	SSDK12-25 Air inlet duct alternator panel	1
7	023-0145	SSDK12-25 Control panel housing	1
8	023-0262	SSDK12-25 Control panel rain guard	1
9	023-0226	SSDK12-25 Control panel door	1
10	023-0203	SSDK12-25 Polycarbonate door	1
11	023-0012	SSDK12-25 Multi/Dualvoltage control panel	1
12	023-0275	SSDK12-25 Control panel door catch	1
13	023-0140	SSDK12-25 Gland plate	1
14	023-0107	SSDK12-25 Air inlet duct base	1
15	023-0136	SSDK12-25 Battery tray	1
16	023-0154	SSDK12-25 Battery bracket	1
17	023-0108	SSDK12-25 Alternator channel	1
18	023-0114	SSDK12-25 Skid base angle bracket	4
19	023-0106	SSDK12-25 Engine channel	1
20	023-0184	SSDK12-25 Fuel tank mounting bracket	4
21	023-0126	SSDK12-25 Air outlet louvre	1
22	023-0160	SSDK12-25 Skid base mounting channel	2
23	023-0124	SSDK12-25 Door	2
24	023-0152	SSDK12-25 Engine end panel	1
25	023-0147	SSDK12 V1505 Radiator plate	1
25	023-0194	SSDK16-20 Kubota V1703-2203 Radiator plate	1
25	023-0307	SSDK25 V2003T Radiator plate	1
26	023-0151	SSDK12-25 Engine end panel plate	1
27	023-0122	SSDK12-25 Base	1
28	023-0270	SSDK12-25 Kubota expansion tank bracket	1
29	023-0137	SSDK12-25 1000Kg lifting beam	1

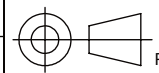
 <b>STEPHILL GENERATORS</b> Phone : +44 (0)1933 677911 Fax : +44 (0)1933 677916	Drawing Number 23-264	Description SSDK12-25 Canopy exploded view	Issue A	Date 09/01/09	Revision New drawing	Colour N/A Material Mild steel	 THIRD ANGLE PROJECTION
	Drawn R Golding		Issue B	Date 19/06/15	Revision Description changed and part numbers updated.		

SSDK12

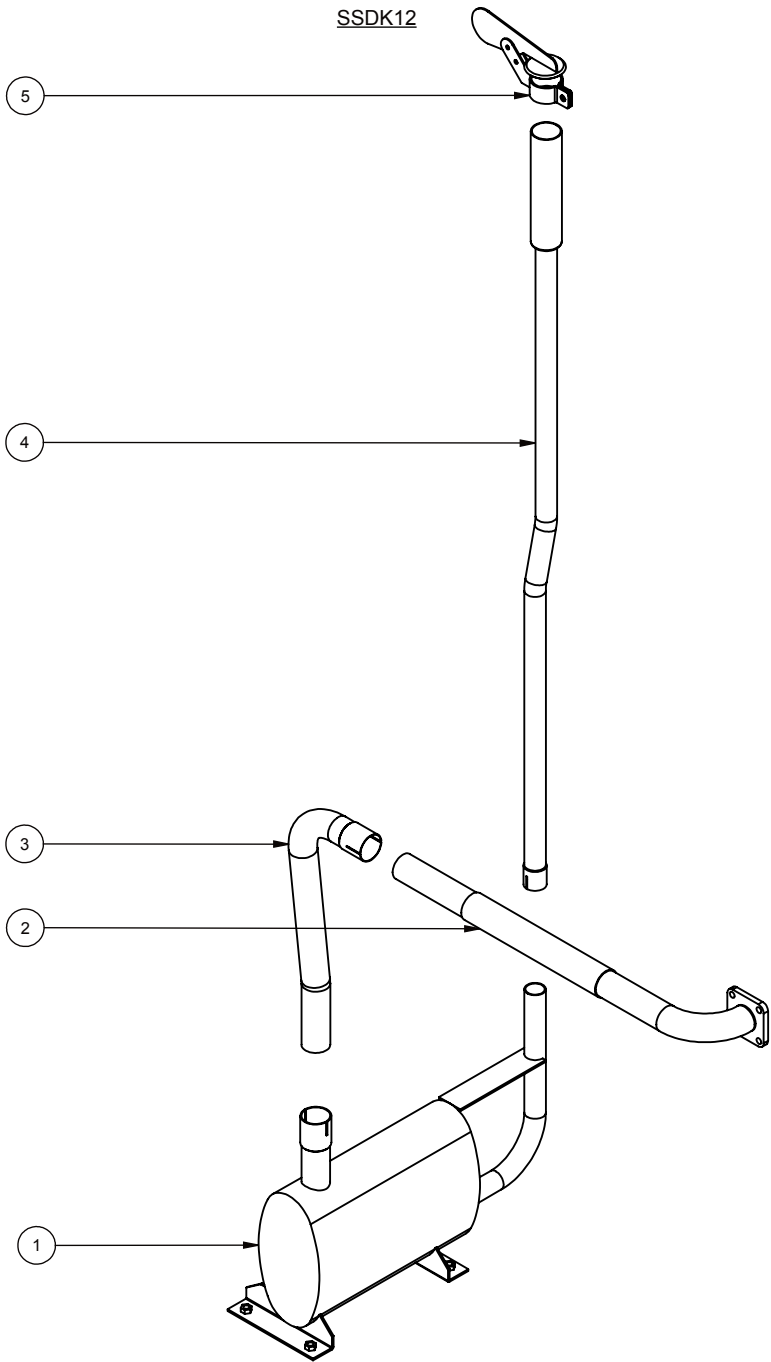

SSDK16 - 25

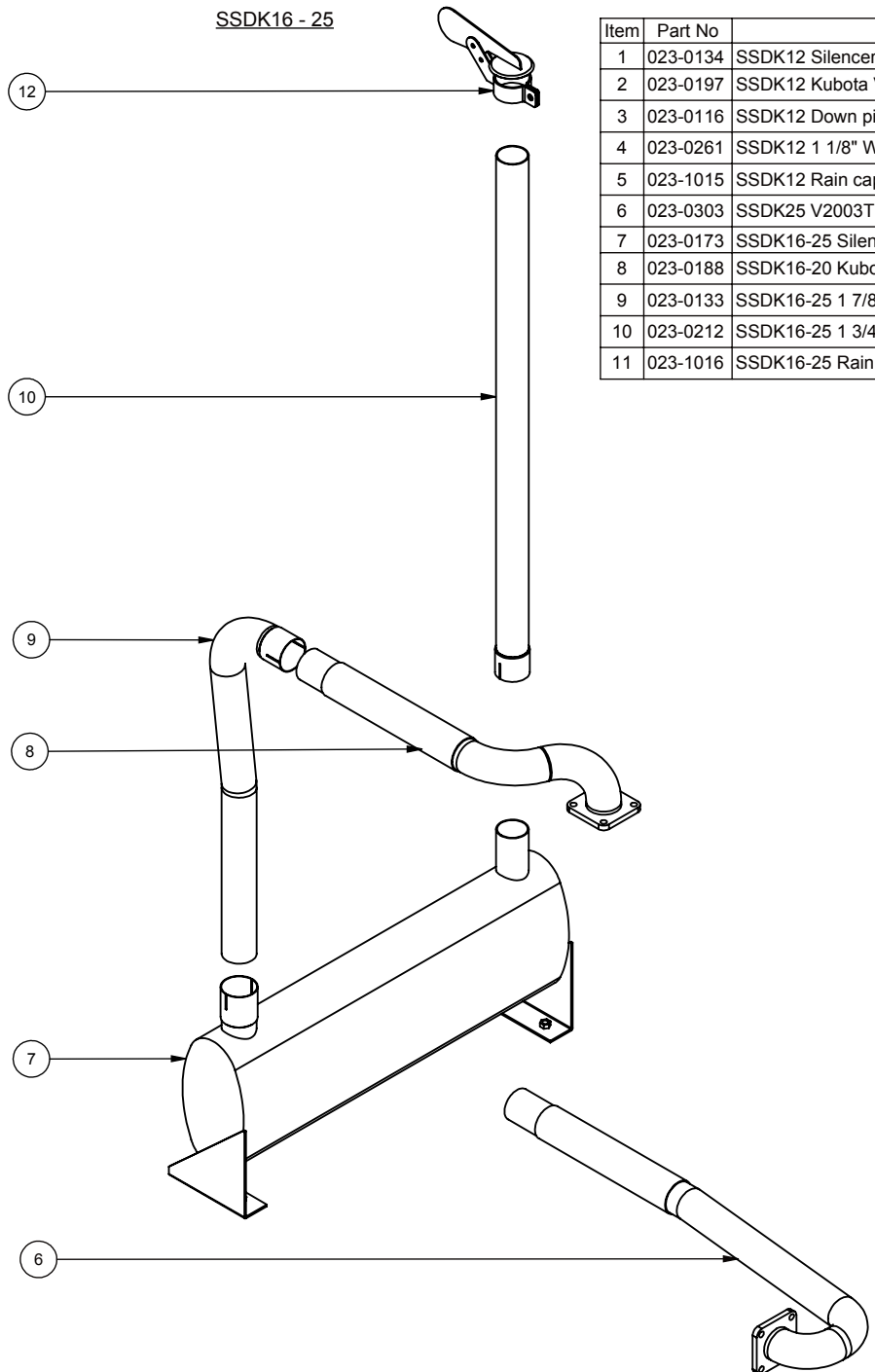

Item	Part No	Description
1	023-0134	SSDK12 Silencer
2	023-0197	SSDK12 Kubota V1505 Manifold pipe
3	023-0116	SSDK12 Down pipe
4	023-0261	SSDK12 1 1/8" Welfare tail pipe
5	023-1015	SSDK12 Rain cap 37-39mm
6	023-0303	SSDK25 V2003T Manifold pipe
7	023-0173	SSDK16-25 Silencer
8	023-0188	SSDK16-20 Kubota D1703 / V2203 Manifold pipe
9	023-0133	SSDK16-25 1 7/8" Down pipe
10	023-0212	SSDK16-25 1 3/4" Straight tail pipe
11	023-1016	SSDK16-25 Rain cap 44-46mm

# ALTERNATOR

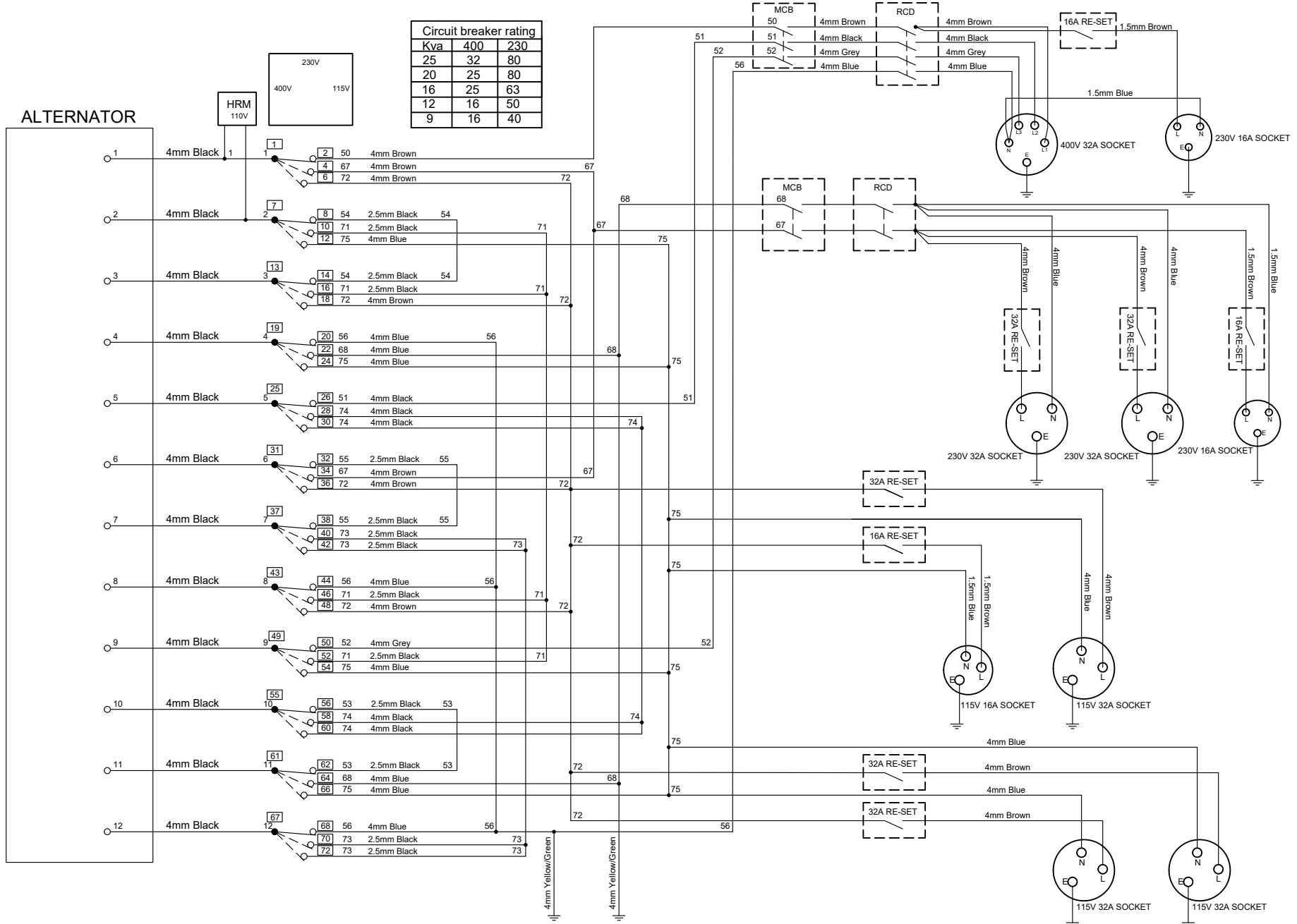

**STEPHILL GENERATORS**  
 Phone 01933 677911  
 Fax 01933 677916

Drawing Number  
 SW12036  
 Drawn  
 R GOLDING

Description  
 SSD MULTIVOLTAGE WIRING  
 400/230/115  
 2006 Wiring colours

Last Number Used  
 75

Issue	Date	Revision
E	23/07/19	Earth to Neutral bond for 400V & 230V moved to the switch. - JD
D	27/11/07	RCD Added for 3 phase. MCBs changed to Re-Sets.
C	29/10/07	Wire no 74 changed to 4mm black.

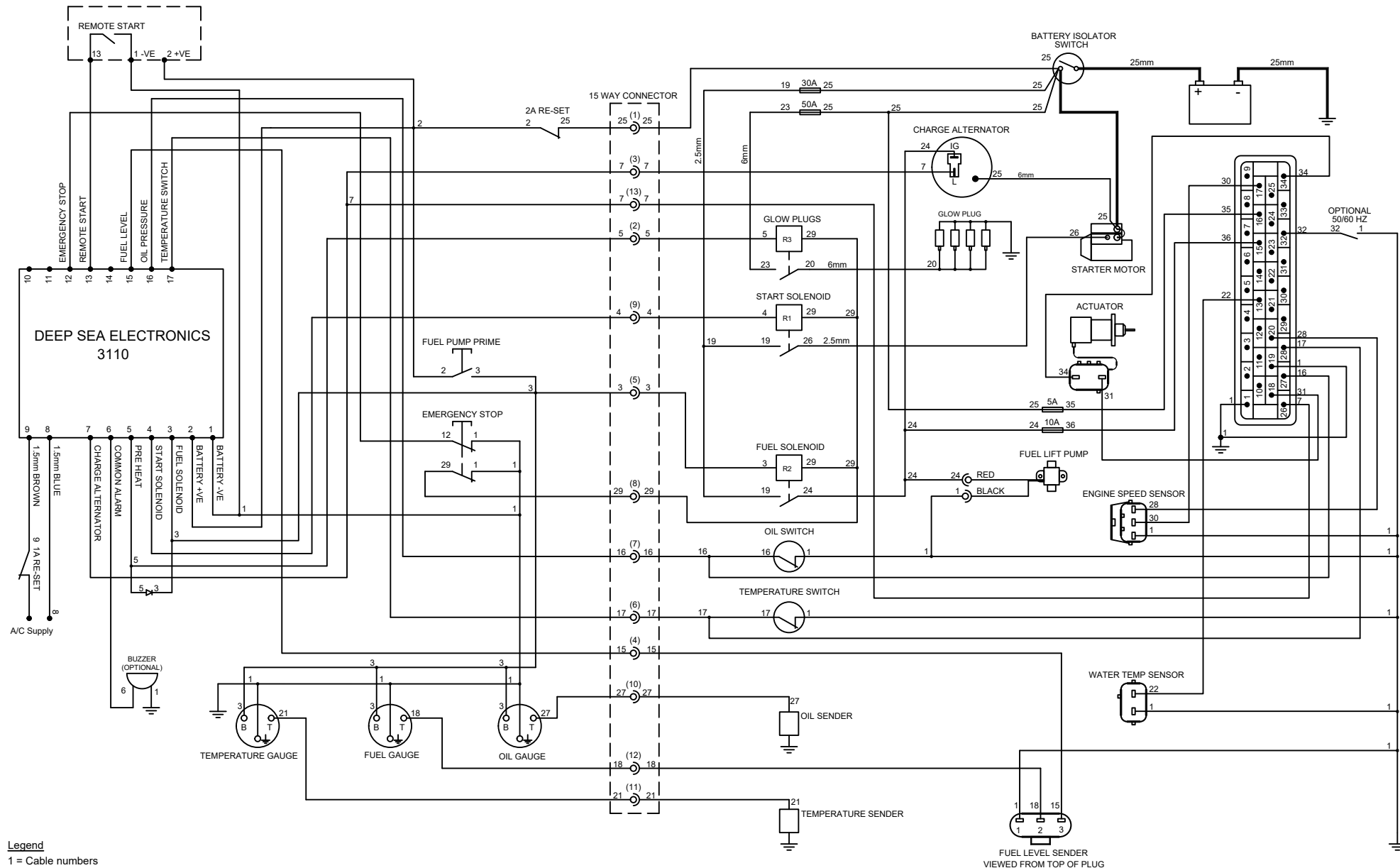

**Legend**  
 1 = Cable numbers  
 (1) = Terminal numbers  
 R1/R2 = 30A Relay  
 R3 = 60A Relay

**Note**  
 All cable except battery cable to be 1.5mm White unless stated.

**STEPHILL GENERATORS**  
 Phone 01933 677911  
 Fax 01933 677916

Drawing Number <b>SW16047</b> Drawn R Golding	Description Kubota 03 M Series ECU DSE 3110
--	--

Last Number Used  
 34

Issue	Date	Revision
A	01/08/19	New drawing

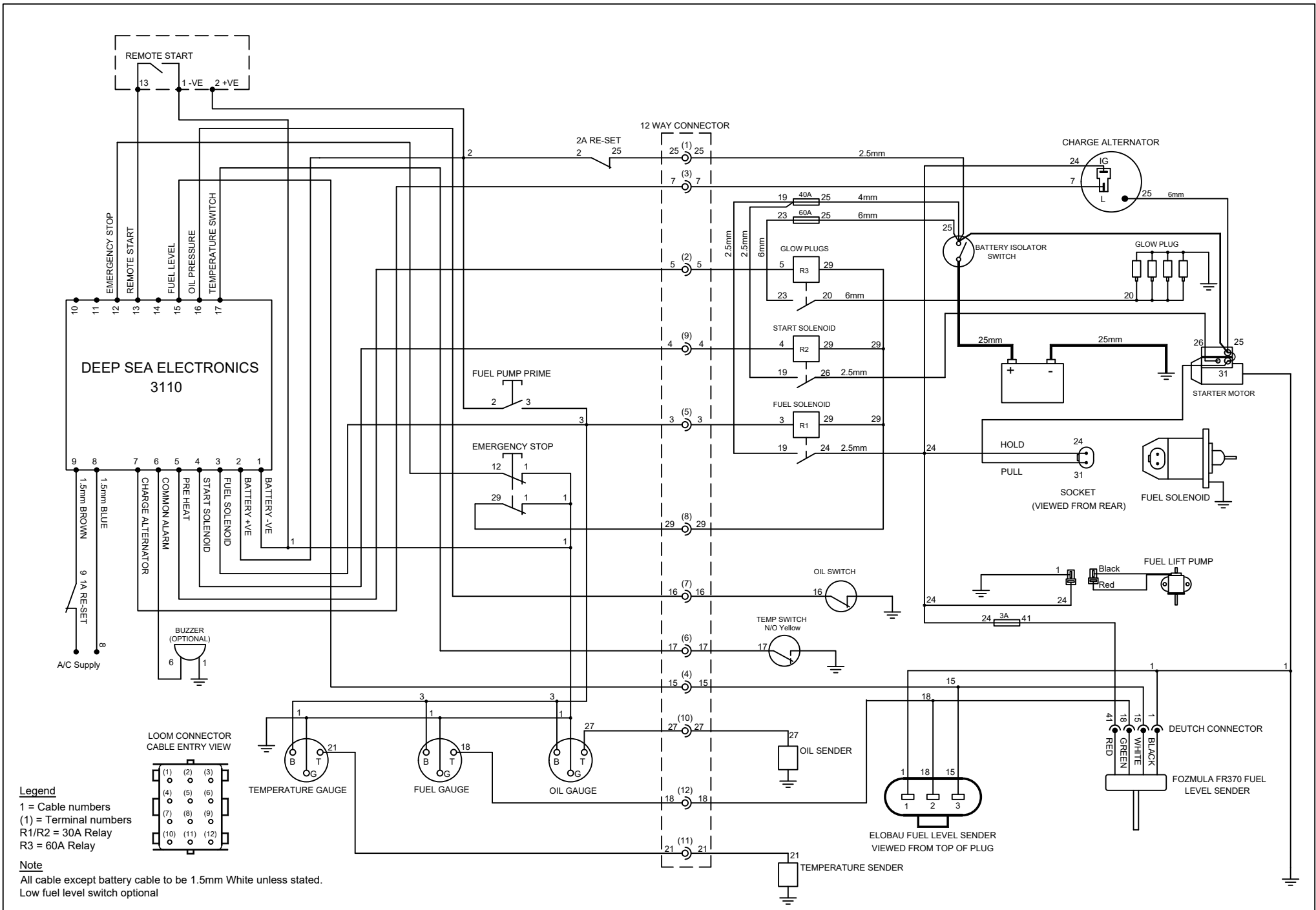

**Legend**

- 1 = Cable numbers
- (1) = Terminal numbers
- R1/R2 = 30A Relay
- R3 = 60A Relay

**Note**

All cable except battery cable to be 1.5mm White unless stated.  
Low fuel level switch optional

**STEPHILL GENERATORS**  
Phone 01933 677911  
Fax 01933 677916

Drawing Number  
SW16061  
Drawn  
R Golding

Description  
Kubota 05 Series DSE 3110 Stage V

Last Number Used  
41

Issue	Date	Revision
A	15/07/21	New Drawing

Blank Page

**STEPHILL<sup>®</sup>**  
**GENERATORS**